

#16



"Proud to be the Installers' Friend for Over 50 Years!"

Helping Them To Do Jobs...

SAFER

NO WORKERS BELOW
PREVENTS INJURIES
OR DEATHS

BETTER

RATED AT 4,000 PSI
TENSILE STRENGTH
AT BREAK

**OVER 12X
FASTER**
THAN SPACERS
& CHAIRS



Lowering assembled conduit from above allows other savings – Digging a narrower trench for less excavation, concrete or slurry, shoring and backfill. The savings are huge!



Eliminates dangerous conditions and reduces workers time in trench

QwikDuct
HDPE CUSTOM TEMPLATES

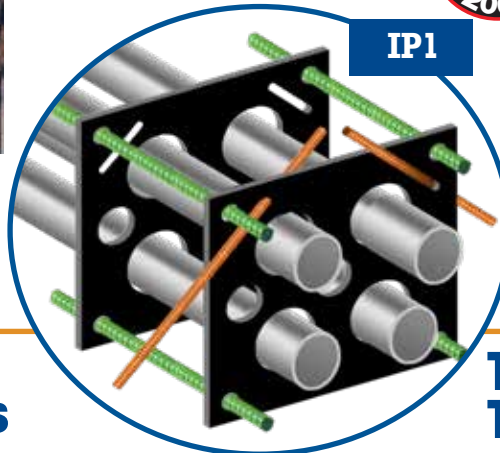

QwikDuct
BORE SPACERS

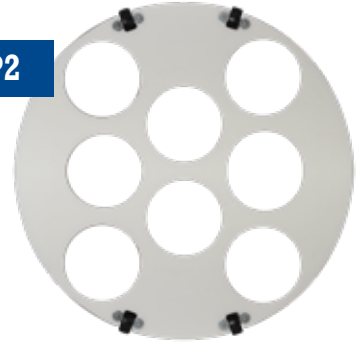

New! **Transition Slip Couplings**



IP12a-h

NO REEMING BITS REQUIRED
Sizes Range From 1/2" Thru 6"



IP15

PVC 1pc
Reaming
Bit

Transition Tapered Couplings



REEMING BITS REQUIRED
Sizes Range From 1/2" Thru 6"

IP13a-g

Box Support Plates

Installs Vertically or Horizontally
All From Only One Support!



IP5

The "Original"

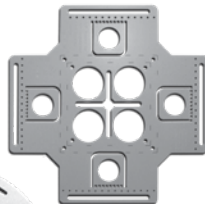

IP6d

2-Way
with
Fingers

IP6c

Modified
Round
Round
Installs
Horizontally
and Vertically



IP6

4-Way

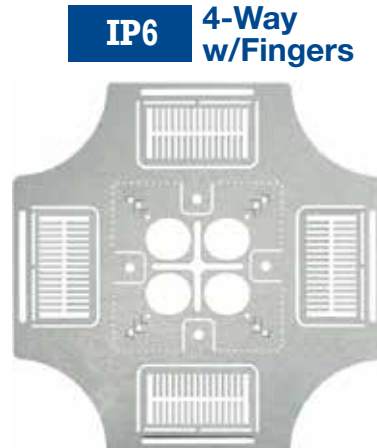

IP6

4-Way
w/Fingers

Eliminates ALL Clamps thru
2" Conduit for 8 x 8 Boxes

IP7

20" x 20" or 28" x 28"
Support Plate

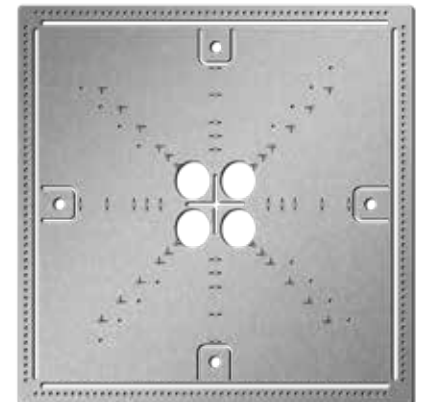

Supports Up Thru 16"x16" J-Box

Visit Our Website for New Products Constantly Being Invented

DO YOU HAVE IDEAS? PLEASE CALL US!

800-233-8595

spproducts.com info@spproducts.com

Sixteenth Printing 6-1-2023

1. To care for our country, industry and electricians by encouraging everyone to buy and install quality made in U.S.A. innovative products for **SAFER – BETTER – FASTER** jobs.
2. Provide opportunity with fair compensation for current and future generations in this country.
3. Develop and promote products that help accomplish these goals.
4. Be the electricians' friend by providing them the satisfaction of making a valuable contribution to the industry plus receiving fair compensation for their ideas.
5. Provide excellent quality and service with competitive pricing.

For more information, samples, literature, product meeting, quotation or to place an order call us. Also, if you have ideas for products we'll help you patent & market them plus pay you an excellent royalty.

Mikel Bishka	Prefab & Quotation Mgr. mikelb@spproducts.com	Cell (815) 353-5500
Suresh Patel	Production Manager sureshp@spproducts.com	Cell (224) 659-3814
Paul Vrame	Vice President paulv@spproducts.com	Cell (815) 451-6335
Marcos Garcia	Western Regional Mgr. marcosg@spproducts.com	Cell (702) 592-4990
Gary Wombough	Eastern Regional Mgr. gwombo@spproducts.com	Cell (443) 253-6142
Rhodney Honeycutt	Southeast Regional Mgr. r@rhoneycutt.com	Cell (828) 381-2395
Michael Barron	Factory Area Sales mbarron@spproducts.com	Cell (312) 659-5972
Georgia Kraemer	Administration georgiak@spproducts.com	Office (800) 233-8595
Tom Lowe	Engineering/Quality Control thomasl@spproducts.com	Office (800) 233-8595
Tim Graham	Warehouse Manager timg@spproducts.com	Office (800) 233-8595
Ana Silva	Administrative Asst. asl@spproducts.com	Office (800) 233-8595

SP Products' philosophy and dedication to making valid contributions to the industry began with

"Econo Whips"

Originated in 1966...



No Center Stop Coupling



Pre Fabricated Assemblies



...Our Whip Machine in 1969

- Any size, length, type – steel or aluminum flexible conduit, MC Cable, Liquidtite, Cord Romex, etc. with any type connectors attached
- Specify components required.
- Conductors stripped
- Locknuts secured rubber bands

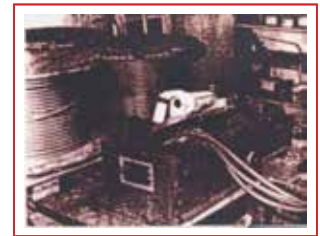

...Plus Numbered and/or Lettered Bundled Wire for Power, Controls, Voice & Data in 1983

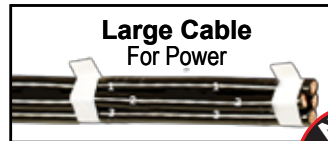

Large Cable For Power



Trees – Set up one reel and pull to hit several locations

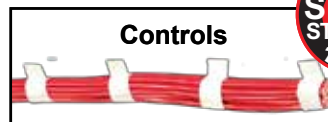

Controls

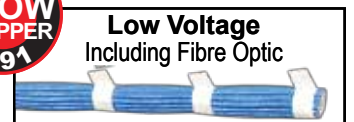

Low Voltage Including Fibre Optic



NECA SHOW STOPPER 1991

Maximum Length 200 feet

And 1997 Harnesses in Flexible Conduit



We Can Make an Unlimited Variety of Special Products to Help You Solve Problems to be Safer and More Profitable!



PATENT PENDING PATENTED



LABELS APPLY TO PRODUCTS ONLY WHERE SHOWN ABOVE

**730 Pratt Boulevard • Elk Grove Village, IL 60007
P: (847) 593-8595 • F: (847) 593-8629 • Toll-free (800) 233-8595
E: info@spproducts.com • www.spproducts.com**

SP1-2

★ = New Products

New Products = ★

Wire Assemblies

- EZ1-1a** EZ Pull/EZ Read Home Runs, Networks, Round Robins, Full Boats
- EZ2-2a** EZ Pull/EZ Read Wire Harnesses for Power, Controls and Voice & Data
- EZ3** EZ Pull/EZ Read Wire Harness
- EZ3a** Pre-Wired Flexible Conduit
- EZ3b** THNN Outer Diameter Chart
- EZ4** Phase Wire Marker

Installed Products

- IP1** QwikDuct HDPE Template
- IP2** QwikDuct HDPE Template Order Info
- IP2a** QwikDuct Template HDPE Bore Spacers
- ★ **IP2b** PVC Driver for Joining SCH 40/80 PVC Conduit
- IP2c-d** QwikDuct HDPE Template Applications
- IP3** QwikDuct HDPE Template Custom Feet
- IP3a** PVC End Bell Adapter
- IP3b** PVC Offset Couplings SCH 40 Only & Sizing Chart
- IP3c** Male Threaded PVC Offset Couplings & Sizing Chart
- ★ **IP3d** PVC Running Thread for PVC Conduit SCH 40/80
- IP4** Split Steel Nuts
- IP5** "The Original" 2 Way Box Support Plate
- IP5a** "The Original" 1/2 Box Support Plate
- IP6** 4-Way Box Support Plate
- IP6a** 2-Way Box Support Plate
- IP6b** "Original" Round & Modified Round Box Support Plate
- IP6c** Universal Round Box Support Plate
- IP6d** 2-Way w/Split Fingers Box Support Plate
- IP7** 4-Way w/Split Fingers Box Support Plate
- IP8** 20" x 20" & 28" x 28" Junction Box Support Plate
- IP8a** Grid System Junction Box Support Plate
- IP9** "Quick Pipe" Roof Conduit Support
- IP10** Nylon Wrap-Around Conduit Straps
- IP11** Trapeze Brackets 4/5/6/8 Conduits
- IP11a** Trapeze Brackets Application
- IP11b** Trapeze Brackets "Lay In" or "Feed Thru" for Larger Conduits
- IP11c** Wide Bottom Flange & Custom Trapeze Brackets
- IP12** PVC Slip Fit to: Galvanized Rigid; Flexible; Liquidtite; Aluminum; EMT; Stainless Steel; End Bell Smooth Bushing;
- ★ **IP13¹** Transition Couplings SCH 40/80 PVC to: PVC; EMT; Rigid; Flexible; EMT Compression; Sealtite; Aluminum; Stainless Steel; End Bell Galvanized Rigid; Smooth Bushing; Inside to PVC Inside; Threaded PVC; Tapered PVC Threaded; MC Cable; PVC Reducer; End Bell to Galvanized Rigid; End Bell to EMT; End Bell to Liquidtite; End Bell to Flexible
- IP13²** Transition Couplings SCH 40/80 Application
- IP14** End Bell Adapter SCH 40/80
- IP14a** Threaded End Bell Adapter SCH 40/80
- IP15** 1 Piece PVC Reaming Bit for SCH 40/80 PVC Conduits
- ★ **IP15a** 1 Piece Chamfer Bit for SCH 40/80 PVC Conduits
- ★ **IP16** 1 Piece Chamfer Bit for Aluminum Conduit
- IP17** No Center Stop Slide On Coupling
- IP18** Box Brackets for Masonry Block Walls
- IP18a** Adjustable Back Box Support



Installed Product

- 4-Conduit Threaded Block Support from Only One Rod **IP19**
- 4-Conduit Non-Threaded Block Support from Only One Rod **IP20**
- Support Hangers **IP21**
- Qwik Block Box Support **IP21a**
- Stub Up Slip Couplings **IP22**
- Original Cinch Clamp **IP23**
- Box Support Bracket for Fire Alarm, Speakers, Strobes, etc. **IP24**
- Original "Big O" **IP25**
- "Big O" Flat Box Support Bracket Application **IP26**
- "Big O" Flat Box Support Bracket Application **IP26a**
- Dual Wall Box Support Bracket **IP27**
- Box Support Wall Bracket **IP27a**
- Electro Post EP-10 Box Support Bracket **IP27b**
- Conduit Plug with ID Tag and Hole for Pull String **IP27c**
- Flat Fixed Position 1-Box Support Bracket **IP28**
- Flat Fixed Position 2-Box Bracket Support **IP28a**
- Flat Fixed Position 3-Box Bracket Support **IP28b**
- Flat Fixed Position 4-Box Bracket Support **IP28c**
- Custom Mounting Plates **IP29**
- Custom Mounting Plates (Continued) **IP29a**
- Slicknut Bushing Adapter for Pulling & Grounding Wire **IP30**
- Slicknut Bushing Adapter for Pulling Wire **IP31**
- EZ Hangers in T Bar Ceiling **IP32**
- Mounting Brackets for EZ Hangers in T Bar Ceiling **IP33**
- Vertical, Ceiling Adjustable Bar Hanger Assembly **IP34**
- Custom Engraved Nameplates and Labels **IP35**

Prefabricated Assemblies

- Custom Prefabricated Cables **PFA1**
- Prefabricated Assemblies **PFA2**
- Prefabricated Assemblies (Continued) **PFA3**
- Adjustable Depth Mud Rings **PFA4**
- Grounding Pigtails **PFA5**
- Vertical, Ceiling Adjustable Bar Hanger Assembly **PFA6**

Tools & Equipment

- Snap On/Off Reusable Steel Protective Covers **TE1**
- Rigid Pipe Joiner **TE2**
- Lamp Guard **TE3**
- Poly Foam Box Insert **TE4**
- Cut'N'Catch **TE5**
- 1 Piece PVC Reaming Bit for SCH 40/80 PVC Conduits **TE6**
- 1 Piece Chamfer Bit for SCH 40/80 PVC Conduits **TE6a** ★
- 1 Piece Chamfer Bit for Aluminum & Galvanized Rigid Conduit **TE6b** ★
- Live Panel Lockout Brackets **TE7**
- Live Panel Temporary Covers **TE8**
- Small Portable Cable Pullers **TE9**
- Anchor Bolt Template **TE10**
- Anchor Bolt Template Light Rail Jobs **TE11**
- PVC Conduit Bender **TE12**
- Dry Wall Cut Out Templates **TE13**
- PVC Driver **TE14** ★
- INDEX**



PATENT PENDING
PATENTED



LABELS APPLY TO PRODUCTS ONLY WHERE SHOWN ABOVE

730 Pratt Boulevard • Elk Grove Village, IL 60007
 P: (847) 593-8595 • F: (847) 593-8629 • Toll-free (800) 233-8595
 E: info@spproducts.com • www.spproducts.com

EZ Pull – EZ Read



Home Runs, Networks Round Robins, Full Boats

Master Pulling Reels
HOME RUNS



SAFER - Set up only one reel. Approximately 50% of all home runs pulled on jobs throughout the year are common. Eliminates constantly handling and loading many heavy reels while installing the wire and again handling, hauling, and storing, partial reels of wire back at the shop at great expense.



Avoid expensive ringing out, tagging each conductor with costly markers that often are incorrect or fall off.

- **Cross tape only with easy to remove tabs for faster easier pulling.**
- Also, separate wires allow pulling individual wires in or out without removing entire harness.
- Conductors are easily added or removed later. Nylon lacing also available.
- Avoid expensive ringing out, tagging each conductor with costly markers that often are incorrect or fall off.
- Every wire tested for quality.
- Extra footage to guarantee length.
- Quantity discounts and labor only orders (customer supplies all material other than SP proprietary items) available for greater savings.
- If manufacturers' brands are not specified equals will be supplied.
- Assemblies are UL Listed provided all components are UL.
- Labor only orders negotiated
- Certificates of insurance at no charge for pay outs when storing.
- Conductors carefully inspected for excellent quality plus reels properly marked & shipped flat or standing upright on skids for easier unloading & handling on job sites.
- 2500 foot reels from manufacturers often run short. Home runs will only be as long as shortest reel of the conductors involved plus some footage loss when striping or printing each conductor. Allowed for SP to order longer reels.

Catalog #	Description	Reel Size	lbs./ Reel
#12 THHN Solid and Stranded			
HR 5C 12SOL 2500	5 Conductor #12 THHN Solid x 2500 foot Reel no wires printed or striped	22 w x 30 h	375
HR 5C 12STR 2500	5 Conductor #12 THHN Stranded x 2500 foot Reel and same as above -or- x 2500 foot reel no wires printed or striped	22 w x 30 h	375
HR 7C 12SOL 2500	7 Conductor #12 THHN Solid x 2500 foot Reel 3 Neutrals identified and plus 4 wires not printed or striped	22 w x 30 h	525
HR 7C 12STR 2500	7 Conductor #12 THHN Stranded and same as above -or- x 2500 foot reel - 3 Neutrals identified and plus 4 wires not printed or striped	22 w x 30 h	525
#10 THHN Solid and Stranded			
HR 5C 10SOL 2500	5 Conductor #10 THHN Solid x 2500 foot Reel no wires printed or striped	28 w x 36 h	600
HR 5C 10STR 2500	5 Conductor #10 THHN Stranded same as above	28 w x 36 h	600
HR 7C 10SOL 2500	7 Conductor #10 THHN Solid x 2500 foot Reel 3 Neutrals identified and plus 4 wires not printed or striped	28 w x 36 h	840
HR 7C 10STR 2500	7 Conductor #10 THHN Stranded x 2500 foot Reel 3 Neutrals identified and plus 4 wires not printed or striped	28 w x 36 h	840

**Tell Us What You Need
– We'll Make It!**

Customer must satisfy all codes and owners' specifications.



PATENT PENDING
PATENTED



LABELS APPLY TO PRODUCTS ONLY WHERE SHOWN ABOVE

730 Pratt Boulevard • Elk Grove Village, IL 60007
P: (847) 593-8595 • F: (847) 593-8629 • Toll-free (800) 233-8595
E: info@spproducts.com • www.spproducts.com

EZ1-1a

EZ Pull - EZ Read Wire Harnesses



CABLE

**Striped or Numbered
& Lettered Conductors**



CIRCUIT SIZES

Eliminates Ringing Out & Tagging

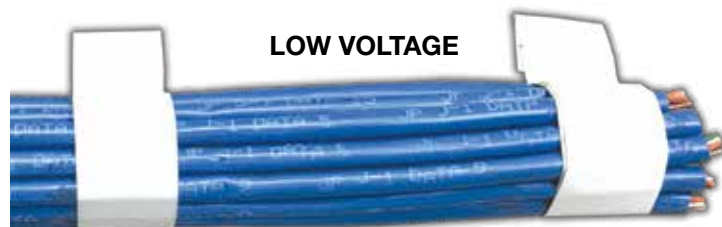

LOW VOLTAGE

#18 thru #1/0 Gauge Wire: THHN, XHHW, XLP/USE, EPR, HYPALON, etc. or equal size Cat 5 or 6, enhanced Cat 5 or 6 low voltage. Plus all other manufacturers brands and other types of wire including low voltage cables.

NOTE: We strongly recommend using water based pulling lubes when pulling silicon and other similar types of wire insulation which DO NOT allow our printing to properly adhere. In this case we can make wire markers with any nomenclature required and apply them at any location of the harnesses on the conductors per customers specification.



**ANY NUMBER OF
CONDUCTORS
For Example:**

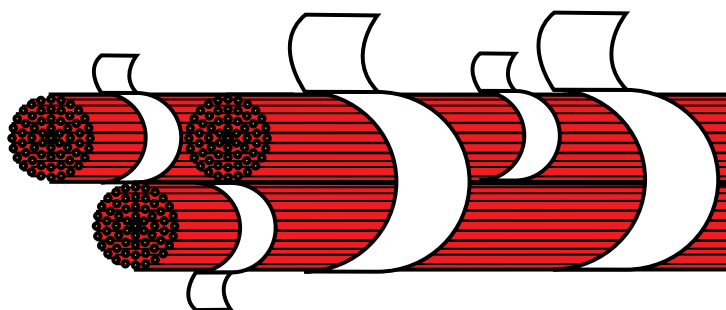

**705/C - #14 THHN Stranded Conductors
Were Used on a Large Job in California
with the following UV printing**

SPARE AL07-CCS-1 SPARE AL07-CCS-1

*Excellent adhesion and any combination
of numbers, letters or symbols repeated
every half inch along the entire length
of each conductor.*

WITH VIRTUALLY NO MISTAKES!

Set Up and Pull Off 1 Reel - Eliminates Wire Pulling Equipment

Customer must satisfy all codes and owners' specifications.



**PATENT PENDING
PATENTED**



LABELS APPLY TO PRODUCTS ONLY WHERE SHOWN ABOVE

730 Pratt Boulevard • Elk Grove Village, IL 60007

P: (847) 593-8595 • F: (847) 593-8629 • Toll-free (800) 233-8595

E: info@spproducts.com • www.spproducts.com

EZ2-2a

EZ Pull - EZ Read



Wire Harnesses for Power, Controls, Voice & Data



SAVE OVER
40%
ON WIRE
PULLS!



NECA
SHOW STOPPER
1991

NECA
SHOW STOPPER
1991

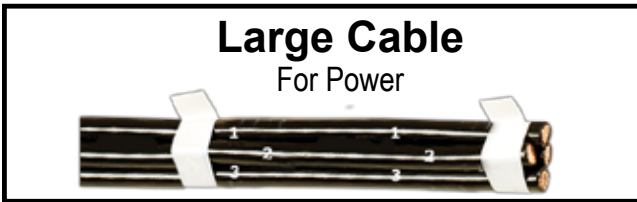
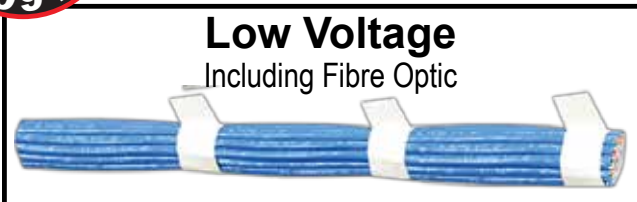
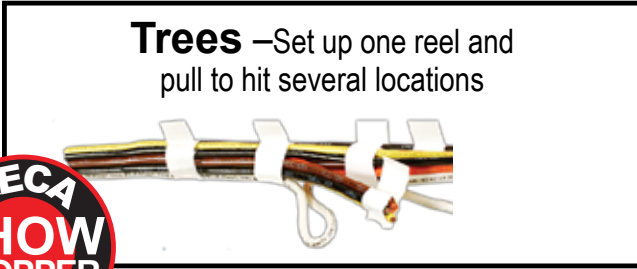

Pre-Wired Flexible Conduit Custom Assemblies

We invented and introduced these products to the electrical industry in 1981, 1991 & 1997

- **Up thru 200 foot long lengths** any type of wire or cable, including: fibre optic, in any type of flexible steel or aluminum, liquidtight, ENT, NMLT, etc. conduit.

NOTE: Low voltage and power cable should not be combined.

- Conductors printed with any combination of numbers, letters or symbols repeated every half inch along their length.
- Any color PVC jacket and thicknesses available for greater protection in wet locations, corrosive areas or embedding in concrete.
- Quantity discounts, labor only orders (customer supplies wire) and firm price blanket orders available.
- If manufacturers' brands are not specified equals will be supplied.

PV Cable Harnesses Also Available for Solar & Wind Farms



PATENT PENDING
PATENTED



LABELS APPLY TO PRODUCTS ONLY WHERE SHOWN ABOVE

730 Pratt Boulevard • Elk Grove Village, IL 60007
P: (847) 593-8595 • F: (847) 593-8629 • Toll-free (800) 233-8595
E: info@spproducts.com • www.spproducts.com

EZ3-3a

THHN Copper Harnesses

Approximate Outer Diameters



Wire Size	Single OD	NUMBER OF CONDUCTORS (Size shown in inches)									
		3	4	5	6	7	19	37	61	91	127
18	0.096	0.192	0.221	0.288	0.288	0.288	0.480	0.672	0.86	1.060	1.248
16	0.106	0.212	0.244	0.318	0.318	0.318	0.530	0.742	0.954	1.166	1.378
14	0.112	0.244	0.258	0.336	0.336	0.336	0.560	0.784	1.008	1.323	1.456
12	0.131	0.262	0.302	0.393	0.393	0.393	0.655	0.917	1.179	1.441	1.703
10	0.165	.0330	0.380	0.495	0.495	0.495	0.825	1.155	1.485	1.815	2.145
8	0.218	0.436	0.502	0.654	0.654	0.654	1.090	1.526	1.962	1.962	2.834
6	0.257	0.514	0.591	0.771	0.771	0.771	1.285	1.800	2.313	2.830	3.341
4	0.328	0.656	0.755	0.984	0.984	0.984	1.640	2.300			
3	0.356	0.710	0.820	1.070	1.070	1.070	1.780	2.490			
2	0.388	0.780	0.890	1.160	1.160	1.160	1.940	2.270			
1	0.450	0.900	1.040	1.350	1.350	1.350	2.250	3.150			
1/0	0.491	0.980	1.130	1.470	1.470	1.470	2.460				
2/0	0.537	1.070	1.240	1.610	1.610	1.610	2.690				
3/0	0.588	1.180	1.350	1.760	1.760	1.760	2.940				
4/0	0.646	1.290	1.490	1.940	1.940	1.940	3.230				
Number of Layers		2	3	3	3	3	5	7	9	11	13

PRE-WIRED FLEXIBLE CONDUIT ASSEMBLIES DO NOT MEET MC CABLE SPECIFICATIONS PER THE NATIONAL ELECTRIC CODE AND DO NOT HAVE FILLERS OR ANY TYPE WRAPPING AROUND CONDUCTORS WITHIN THE FLEXIBLE CONDUIT.

SAFER – BETTER – FASTER

Customer is responsible to ensure Wire Harnesses meet all codes plus owners' and specifying engineers' requirements.



PATENT PENDING
PATENTED



LABELS APPLY TO PRODUCTS ONLY WHERE SHOWN ABOVE

730 Pratt Boulevard • Elk Grove Village, IL 60007
P: (847) 593-8595 • F: (847) 593-8629 • Toll-free (800) 233-8595
E: info@spproducts.com • www.spproducts.com

EZ3b



Phase Wire Marker



Wider Tip for Larger Wires

Cat# (specify color)	Desc.
PWM100	Regular Tip
PWM200	Wide Tip



- Fast drying (in just 30 seconds) paint resists handling, heat and UV Light plus adheres to clean sheath permanently
- Lasts for 1 year from date of purchase provided tube is immediately & properly capped after each use
- **EACH TUBE CAN MARK MORE THAN 600 LINEAR FEET OF WIRE**
- Ideal for Panels, Color Coding and identifying Wiring Circuits, Cat 5 Ethernet plus audio/video and HDMI Cable, Automotive Wire, etc.

Available in the following colors:

B = Black	GR = Gray	V = Violet
BL = Blue	O = Orange	W = White
BRN = Brown	P = Pink	Y = Yellow
GRN = Green	R = Red	

Extremely faster than tape to handle & apply Save Hundreds of dollars per tube



PATENT PENDING
PATENTED



LABELS APPLY TO PRODUCTS ONLY WHERE SHOWN ABOVE

730 Pratt Boulevard • Elk Grove Village, IL 60007
P: (847) 593-8595 • F: (847) 593-8629 • Toll-free (800) 233-8595
E: info@spproducts.com • www.spproducts.com

EZ4

That Help Do Jobs...

SAFER

NO WORKERS BELOW
PREVENTS INJURIES
OR DEATHS

BETTER

RATED AT 4,000 PSI
TENSILE STRENGTH
AT BREAK

**OVER 12X
FASTER
THAN SPACERS
& CHAIRS**



QwikDuct
HDPE CUSTOM TEMPLATES

Patent Pending

IP1



Eliminates dangerous & expensive time working in trench strengthening weak spacers & chairs with tie wire or other methods.

Lowering assembled conduit from above allows other savings – Digging a narrower trench for less excavation, concrete or slurry, shoring and backfill. The savings are huge!

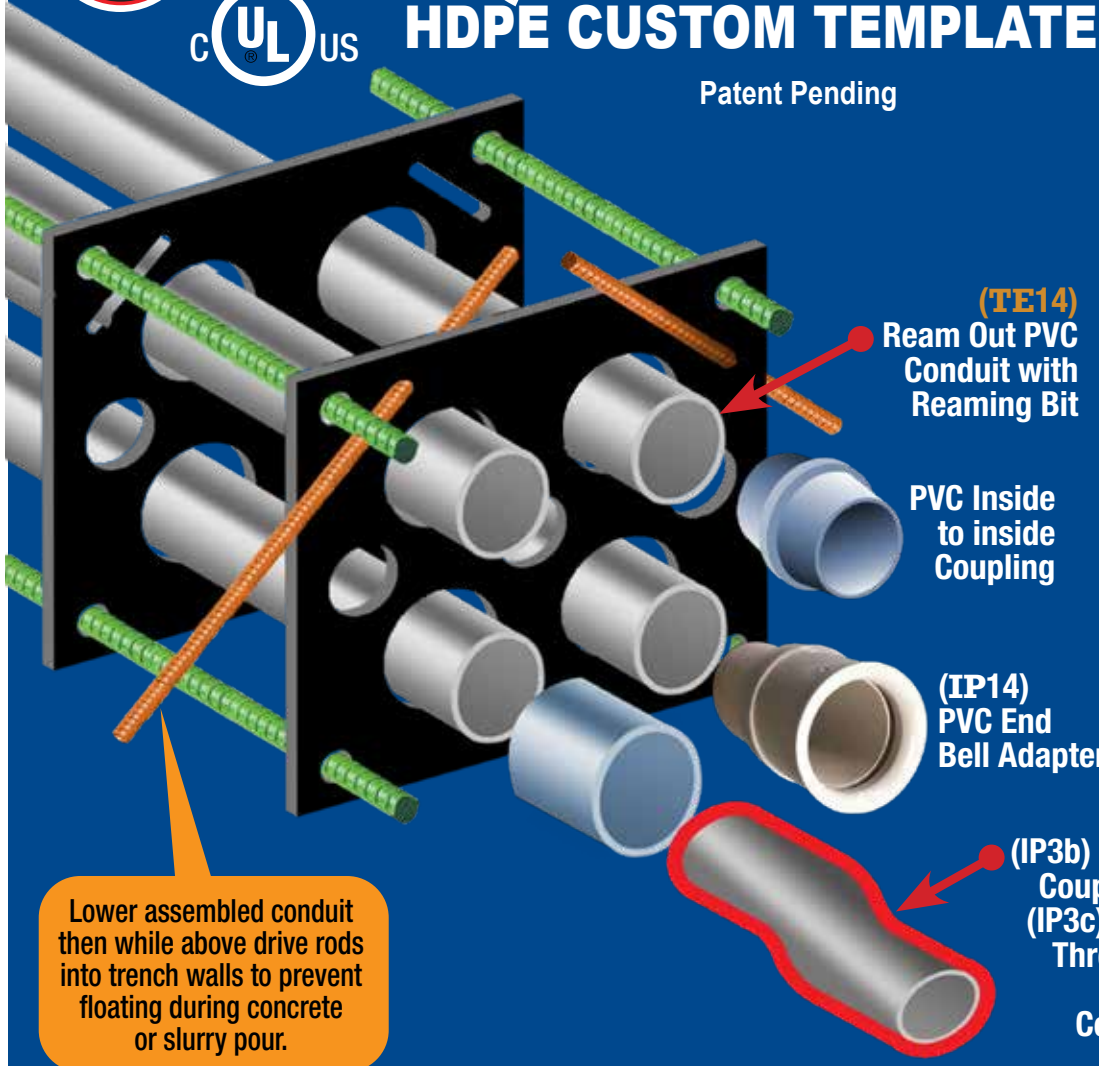

Lower assembled conduit then while above drive rods into trench walls to prevent floating during concrete or slurry pour.

ALSO SUITABLE FOR TRANSFORMER & SWITCHGEAR STUB UPS

Submittals provided with all duct bank quotes



PATENT PENDING
PATENTED



LABELS APPLY TO PRODUCTS ONLY WHERE SHOWN ABOVE

730 Pratt Boulevard • Elk Grove Village, IL 60007
P: (847) 593-8595 • F: (847) 593-8629 • Toll-free (800) 233-8595
E: info@spproducts.com • www.spproducts.com

IP1



QwikDuct HDPE CUSTOM TEMPLATES



WHEN ORDERING CUSTOMER MUST SPECIFY:

1. **Material Thickness 3/8", 1/2", 3/4"**
and Load Rating Required (1/2" & 3/4" are special order materials)
2. Size & Location of Rebar Holes
3. Spacing Between Conduit Openings
4. Rebar Stake Down Slots Required?
5. Diameter of Conduits
6. Footage Between Templates
7. Size & Location of Concrete Flow Holes

WHEN ASSEMBLING ABOVE THE TRENCH:

1. Install Conduits into Templates & Rebar if Required
2. Lower Assemblies into Trench
3. Insert Stake Down Rods into Angled Slots
4. Drive Stake Down Rods into Trench Walls from Above
5. Backfill with Concrete, Slurry, Sand or Gravel etc.

SEE WEBSITE
VIDEO IP1-2

QwikDuct Templates can be used with all standardized trade size conduit specified per NFPA 70 NEC

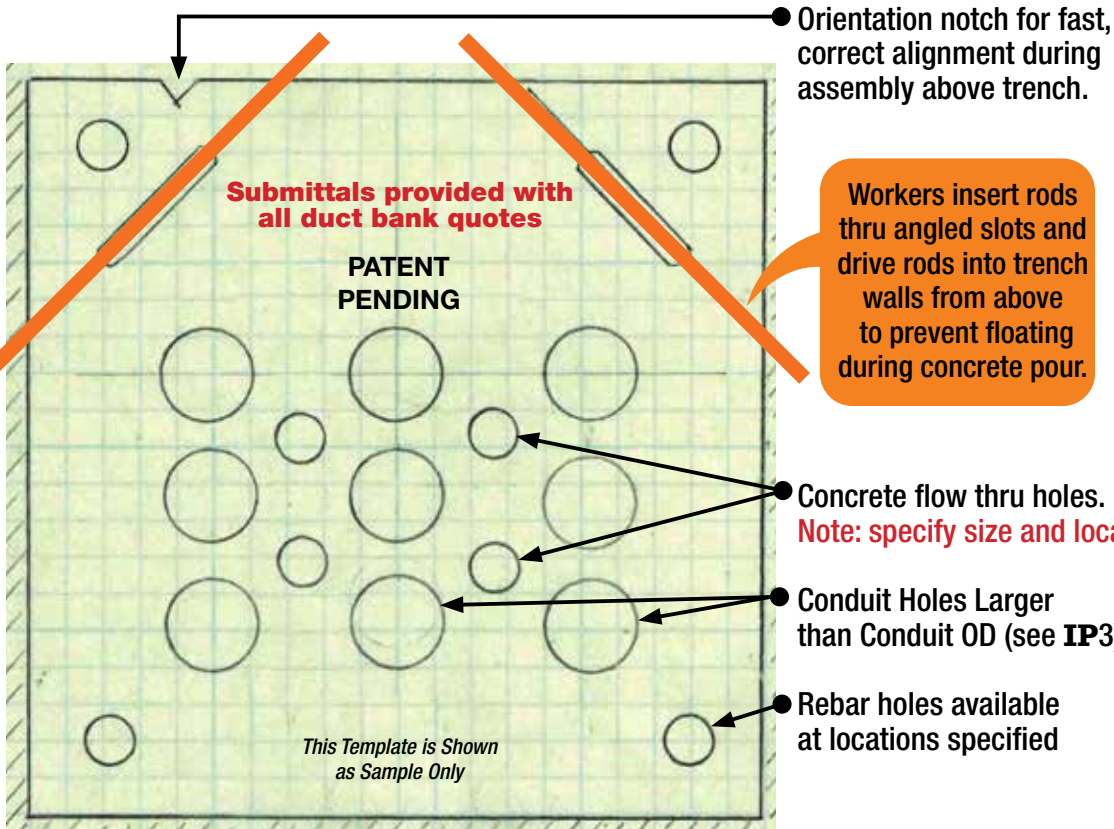

QWIKDUCT HDPE CUSTOM TEMPLATES meet or exceed US Army Corps of Engineers requirement.

Customer must specify larger diameter holes to enable feeding bell ends of conduit from either direction.

PROVIDE SAFER & FASTER INSTALLATION PLUS ALLOW CLOSING TRENCH QUICKER TO REDUCE CHANCE OF DANGEROUS & COSTLY SOIL OR WATER PROBLEMS.

ALSO SUITABLE FOR TRANSFORMER & SWITCHGEAR STUB UPS



PATENT PENDING
PATENTED



LABELS APPLY TO PRODUCTS ONLY WHERE SHOWN ABOVE

730 Pratt Boulevard • Elk Grove Village, IL 60007
P: (847) 593-8595 • F: (847) 593-8629 • Toll-free (800) 233-8595
E: info@spproducts.com • www.spproducts.com

IP2

QwikDuct HDPE Bore Spacers



3/4" HDPE for Greater Strength to Accommodate Assemblies with Wheels.

2" Diameter Wheels are Standard, Larger Size Diameters Available Upon Request

Roll assembled conduit into caissons under obstructions.

WHEN ORDERING CUSTOMER MUST SPECIFY:

1. **Material Thickness 3/8", 1/2", 3/4"** and Load Rating Required ($1/2"$ & $3/4"$ are special order materials)
2. **Size & Location of Rebar Holes**
3. **Spacing Between Conduit Openings**
4. **Rebar Stake Down Slots Required?**
5. **Diameter of Conduits**
6. **Footage Between Templates**
7. **Size & Location of Concrete Flow Holes**
8. **Size, Number & Location of Wheels**

Customer must specify larger diameter holes to enable feeding bell ends of conduit from either direction.



**PATENT PENDING
PATENTED**



LABELS APPLY TO PRODUCTS ONLY WHERE SHOWN ABOVE

730 Pratt Boulevard • Elk Grove Village, IL 60007
P: (847) 593-8595 • F: (847) 593-8629 • Toll-free (800) 233-8595
E: info@spproducts.com • www.spproducts.com

IP2a



PVC Driver

for Joining SCH 40/80 PVC Conduit



1-Piece

Assemble PVC conduits in a Duct Bank on a job site or prefab using the PVC Driver with a Hammer Drill to join 2 pieces of PVC conduit in a matter of seconds.

PVC Driver eliminates extra tools and allows for a clean and safe installation with less labor.

Insert PVC Driver into Hammer Drill and drive PVC Conduit into place with this light weight aluminum tool for **SAFER, BETTER, FASTER** jobs.

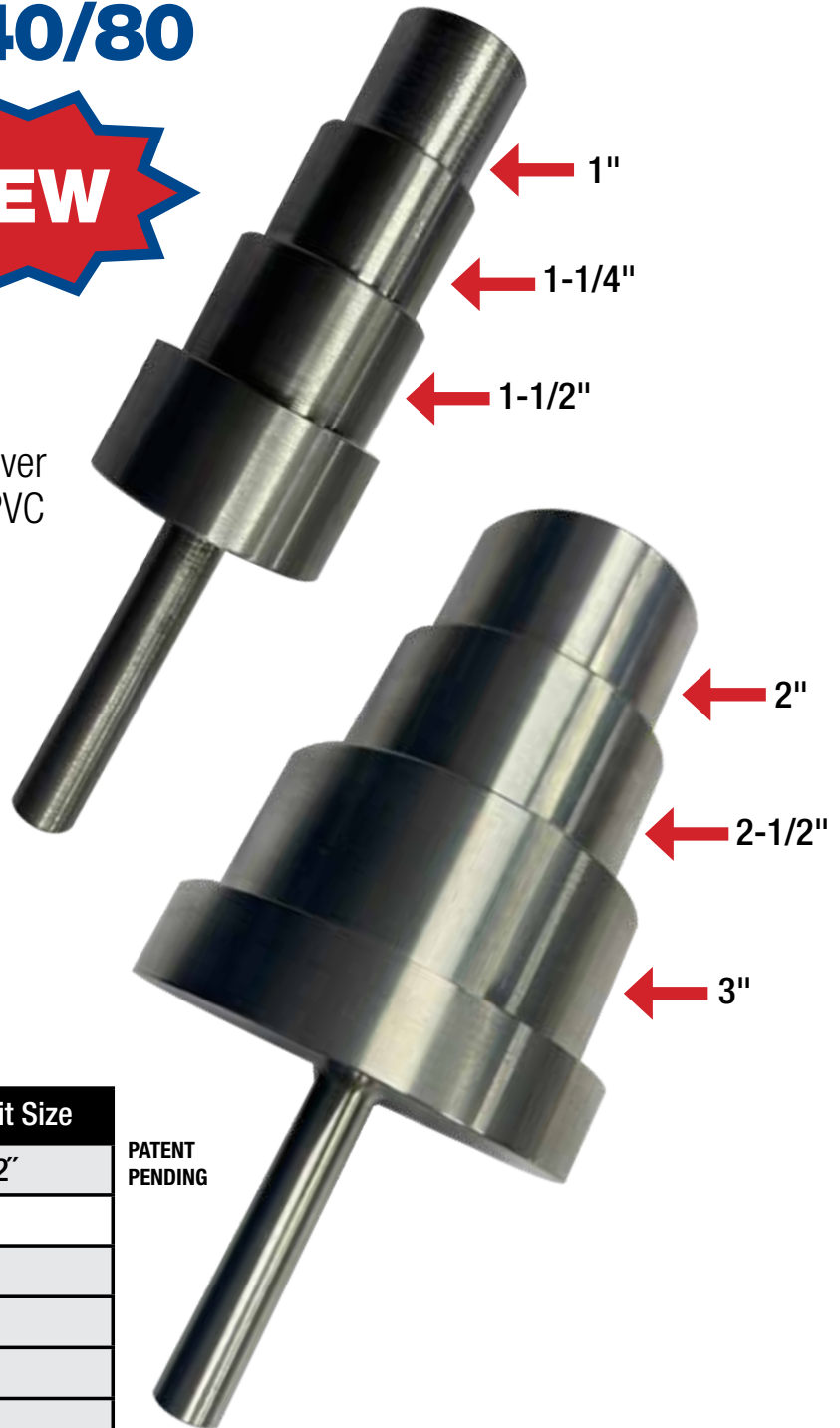

Catalog #	SCH 40/80 PVC Conduit Size
PVCD-100-125-150	1", 1-1/4" & 1-1/2"
PVCD-200-250-300	2", 2-1/2" & 3"
PVCD-350-400	3-1/2" & 4"
PVCD-500	5"
PVCD-600	6"
PVCD-800	8"

PATENT PENDING

Customer must satisfy all codes and owners' specifications.



PATENT PENDING
PATENTED



LABELS APPLY TO PRODUCTS ONLY WHERE SHOWN ABOVE

730 Pratt Boulevard • Elk Grove Village, IL 60007
 P: (847) 593-8595 • F: (847) 593-8629 • Toll-free (800) 233-8595
 E: info@spproducts.com • www.spproducts.com

IP2b



QwikDuct HDPE

CUSTOM TEMPLATES



Please visit spproducts.com to see video IP1 & IP2

Do Jobs SAFER BETTER FASTER! Earn More Profit!

It took two men a full day to assemble the first 20 feet. It required 15 3½" conduits and one 2½" conduit to turn up for a tap box, a few feet away, two of the 3½" and one of the 2½" had to turn up to go in to separate CT cabinets and then turn back down to continue the full length.

On the day of trenching we just moved this section over, and it took four men 4 hours to assemble the remainder of the run. It should take another 12 man hours to make the connection between the 16 conduits the existing stubs out of the building.

Ideal for stubbing up for Transformers & Switch Gear

QWIK DUCT Templates can be used with all standardized trade size conduit specified per NFPA 70 NEC

FREE SPECIAL OFFER!

Contractor customer earns \$1,000 worth of any size 1 Piece Reaming Bits for every \$100,000 purchases of any of SP's products based on their contractor's cost within a 12 month period starting with the date of 1st order of program.

To qualify contractor customer must accept this offer with a dated, signed agreement properly recorded and filed by SP Products and contractor must renew the agreement at the end of every year if he chooses to continue the program.

IMPORTANT!

- Customer is responsible for meeting all specifications on the job and must inform SP if heavier than schedule 80 PVC conduit is installed.
- For heavier loads (steel, rigid, EMT or other heavier conduit) we strongly suggest customer installs rebar on outside perimeter to transfer the load away from the templates.
- Customer is also responsible for calculating and meeting all load bearing specifications.
- Heavier conduit should be fed thru the lower openings in the template if otherwise SP must be informed prior to installation.



PATENT PENDING
PATENTED



LABELS APPLY TO PRODUCTS ONLY WHERE SHOWN ABOVE

730 Pratt Boulevard • Elk Grove Village, IL 60007
P: (847) 593-8595 • F: (847) 593-8629 • Toll-free (800) 233-8595
E: info@spproducts.com • www.spproducts.com

IP2c-d

QwikDuct HDPE



CUSTOM QWIKDUCT TEMPLATE FEET

UL PATENT PENDING

SNAP-ON TEMPLATE

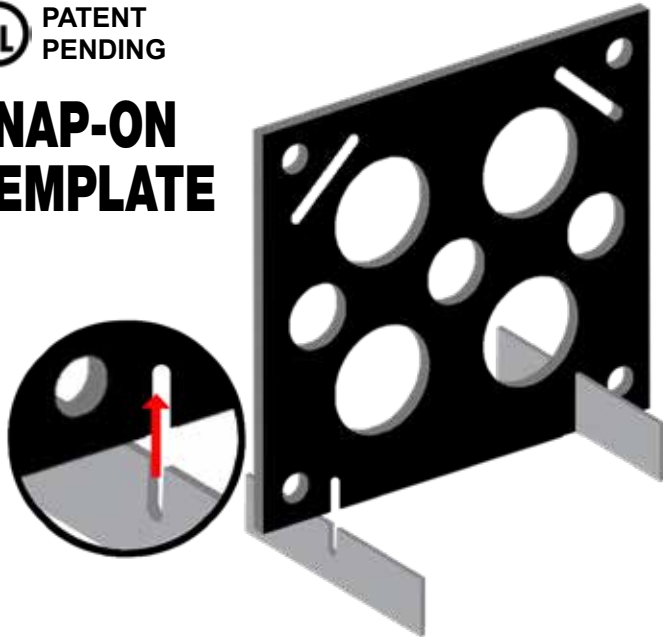

Unique interlock system serves as a base & keeps templates upright

Quickly apply glue if needed to keep feet in place when lowering

UL PATENT PENDING

BOLT-ON TEMPLATE

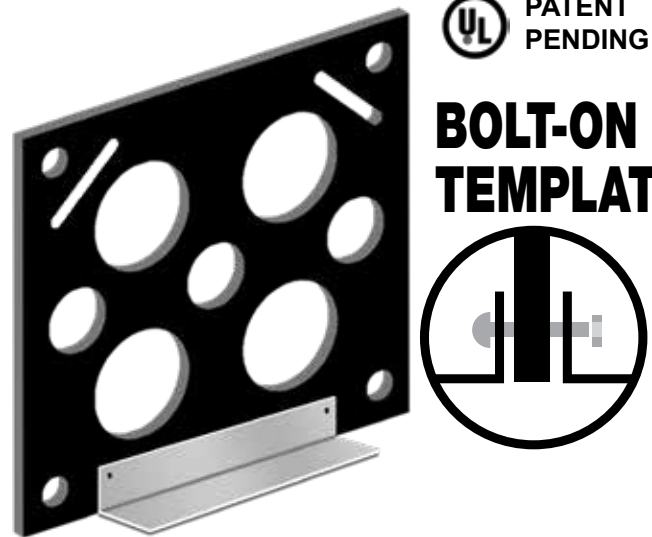

Customer must specify all details. Sold separately or installed by SP. Attach any length 2" tall x up thru 4" wide base, 16 gauge galvanized steel to bottom of templates.

Customer must allow air space to allow concrete flow under templates and feet.

Attach both angle irons with 2 bolts and nuts for each template during assembly on job site before lowering into trench

QWIKDUCT TEMPLATE HOLE SIZING GUIDE

Customer must make certain conduit openings are wide enough to allow the bell end of conduit to be fed thru from either direction if required by specs.

SCHEDULE 40 PVC CONDUIT SIZE (Inches)													
1/2	3/4	1	1 1/4	1 1/2	2	2 1/2	3	3 1/2	4	5	6	8	
SUGGESTED DIAMETER OF CONDUIT HOLE (Inches) For Bell End Clearance													
1 1/4	1 1/2	2	2 1/4	2 1/2	3	3 1/2	4 1/4	5	5 1/4	6 1/4	7 1/2	9 3/4	

NOTE: A MINIMUM OF 1 1/2 OF MATERIAL INCH MUST BE MAINTAINED BETWEEN CONDUIT AND ALL OPENINGS TO COMPLY WITH UL REQUIREMENTS.

Customer must satisfy all codes and owners' specifications.



PATENT PENDING
PATENTED



LABELS APPLY TO PRODUCTS ONLY WHERE SHOWN ABOVE

730 Pratt Boulevard • Elk Grove Village, IL 60007
P: (847) 593-8595 • F: (847) 593-8629 • Toll-free (800) 233-8595
E: info@spproducts.com • www.spproducts.com

IP3

PVC End Bell Adapter

Sizes 1/2" thru 6"
PVC Schedule 40 & 80



PATENT PENDING

Catalog #	Size
PEBA#50	1/2 inches
PEBA#75	3/4 inches
PEBA#100	1 inches
PEBA#125	1 1/4 inches
PEBA#150	1 1/2 inches
PEBA#4200	2 inches
PEBA#250	2 1/2 inches
PEBA#300	3 inches
PEBA#350	3 1/2 inches
PEBA#400	4 inches
PEBA#500	5 inches
PEBA#600	6 inches

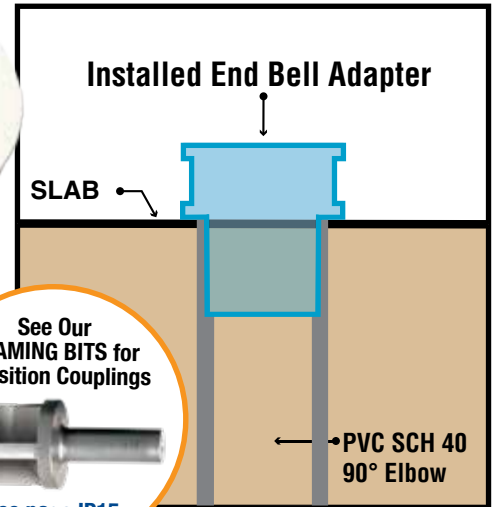

All Above Meet UL651 Plus...
CSA C22.2, No. 85 and US Army Corps
Engineers Specifications

Transitions in Less Than 5 Minutes!
Save Cost on the Rigid Nipple, Tape & Labor
Use for Entire Job - Not Just for Repair

Perfect for use with QwikDuct HDPE Templates for Railway, Highway & Tollway

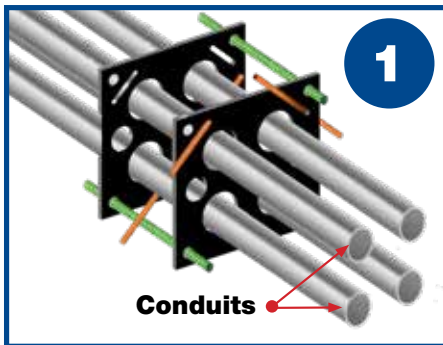

1. Align QwikDuct close to manhole or vault

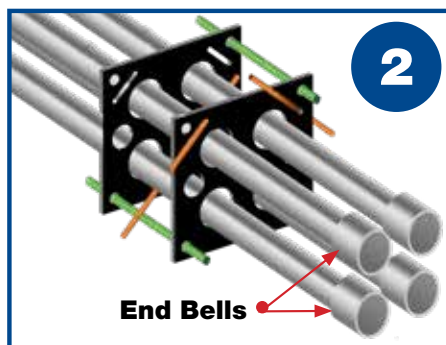

2. Ream out conduits and glue on end bell adapters to each conduit inside or outside manhole or vault

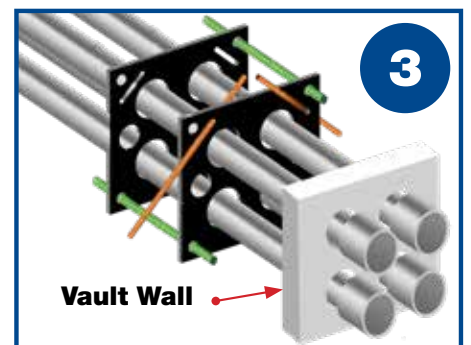

3. Slide conduits with bell end adapters thru manhole openings inside or outside manhole or vault



PATENT PENDING
PATENTED

LABELS APPLY TO PRODUCTS ONLY WHERE SHOWN ABOVE



730 Pratt Boulevard • Elk Grove Village, IL 60007
P: (847) 593-8595 • F: (847) 593-8629 • Toll-free (800) 233-8595
E: info@spproducts.com • www.spproducts.com

IP3a

PVC Offset Couplings



Schedule 40 ONLY

Save at Least
1 Hour per
Installation.

NEW



- PVC Offset used to join conduits when they shift due to stress of concrete pour
- Offset facilitates ease of installation without need to chip out concrete

**OFFSET COUPLINGS
MEET MANDREL TEST
REQUIREMENTS**

PATENT
PENDING

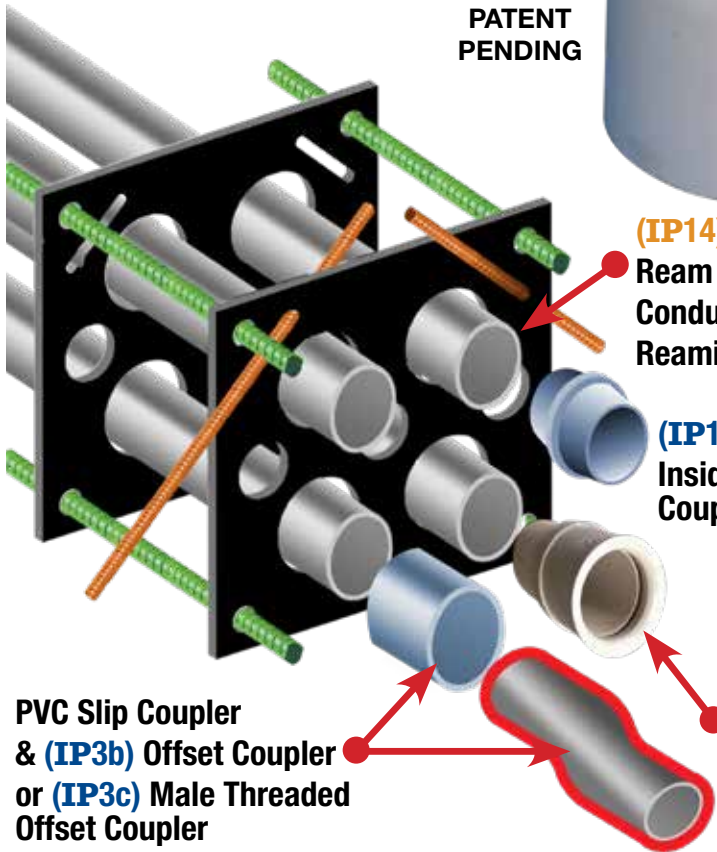

**(IP14)
Ream Out PVC
Conduit with
Reaming Bit**

**(IP13k) PVC
Inside/inside
Coupling**

**(IP14)
PVC End Bell
Adapter**

**PVC Slip Coupler
& (IP3b) Offset Coupler
or (IP3c) Male Threaded
Offset Coupler**

Conduit Sizes 1/2" thru 6" Offset Sizing Chart & Catalog Numbers

Size	Offset	Cat #
1/2"	1/2"	50-PVC-OFFSET 50
	3/4"	50-PVC-OFFSET 75
	1"	50-PVC-OFFSET 100
	1-1/4"	50-PVC-OFFSET 125
	1-1/2"	50-PVC-OFFSET 150
	2"	50-PVC-OFFSET 200
	3"	50-PVC-OFFSET 300
3/4"	1/2"	75-PVC-OFFSET 50
	3/4"	75-PVC-OFFSET 75
	1"	75-PVC-OFFSET 100
	1-1/4"	75-PVC-OFFSET 125
	1-1/2"	75-PVC-OFFSET 150
	2"	75-PVC-OFFSET 200
	3"	75-PVC-OFFSET 300
1"	1/2"	100-PVC-OFFSET 50
	3/4"	100-PVC-OFFSET 75
	1"	100-PVC-OFFSET 100
	1-1/4"	100-PVC-OFFSET 125
	1-1/2"	100-PVC-OFFSET 150
	2"	100-PVC-OFFSET 200
	3"	100-PVC-OFFSET 300
1-1/4"	1/2"	125-PVC-OFFSET 50
	3/4"	125-PVC-OFFSET 75
	1"	125-PVC-OFFSET 100
	1-1/4"	125-PVC-OFFSET 125
	1-1/2"	125-PVC-OFFSET 150
	2"	125-PVC-OFFSET 200
	3"	125-PVC-OFFSET 300
1-1/2"	1/2"	150-PVC-OFFSET 50
	3/4"	150-PVC-OFFSET 75
	1"	150-PVC-OFFSET 100
	1-1/4"	150-PVC-OFFSET 125
	1-1/2"	150-PVC-OFFSET 150
	2"	150-PVC-OFFSET 200
	3"	150-PVC-OFFSET 300
2"	1/2"	200-PVC-OFFSET 50
	3/4"	200-PVC-OFFSET 75
	1"	200-PVC-OFFSET 100
	1-1/4"	200-PVC-OFFSET 125
	1-1/2"	200-PVC-OFFSET 150
	2"	200-PVC-OFFSET 200
	3"	200-PVC-OFFSET 300

Size	Offset	Cat #
3"	1/2"	300-PVC-OFFSET 50
	3/4"	300-PVC-OFFSET 75
	1"	300-PVC-OFFSET 100
	1-1/4"	300-PVC-OFFSET 125
	1-1/2"	300-PVC-OFFSET 150
	2"	300-PVC-OFFSET 200
	3"	300-PVC-OFFSET 300
3-1/2"	1/2"	350-PVC-OFFSET 50
	3/4"	350-PVC-OFFSET 75
	1"	350-PVC-OFFSET 100
	1-1/4"	350-PVC-OFFSET 125
	1-1/2"	350-PVC-OFFSET 150
	2"	350-PVC-OFFSET 200
	3"	350-PVC-OFFSET 300
4"	1/2"	400-PVC-OFFSET 50
	3/4"	400-PVC-OFFSET 75
	1"	400-PVC-OFFSET 100
	1-1/4"	400-PVC-OFFSET 125
	1-1/2"	400-PVC-OFFSET 150
	2"	400-PVC-OFFSET 200
	3"	400-PVC-OFFSET 300
5"	1/2"	500-PVC-OFFSET 50
	3/4"	500-PVC-OFFSET 75
	1"	500-PVC-OFFSET 100
	1-1/4"	500-PVC-OFFSET 125
	1-1/2"	500-PVC-OFFSET 150
	2"	500-PVC-OFFSET 200
	3"	500-PVC-OFFSET 300
6"	1/2"	600-PVC-OFFSET 50
	3/4"	600-PVC-OFFSET 75
	1"	600-PVC-OFFSET 100
	1-1/4"	600-PVC-OFFSET 125
	1-1/2"	600-PVC-OFFSET 150
	2"	600-PVC-OFFSET 200
	3"	600-PVC-OFFSET 300

QwikDuct Templates can be used with all standardized trade size conduit specified per NFPA 70 NEC

SP PRODUCTS, INC
Productivity and value thru ideas



PATENT PENDING
PATENTED



LABELS APPLY TO PRODUCTS ONLY WHERE SHOWN ABOVE

730 Pratt Boulevard • Elk Grove Village, IL 60007
P: (847) 593-8595 • F: (847) 593-8629 • Toll-free (800) 233-8595
E: info@spproducts.com • www.spproducts.com

IP3b

Male Threaded PVC Offset

Schedule 40 ONLY



Save at Least
1 Hour per
Installation.

NEW

- PVC Offset used to join conduits when they shift due to stress of concrete pour
- Offset facilitates ease of installation without need to chip out concrete

**OFFSET COUPLINGS
MEET MANDREL TEST
REQUIREMENTS**



PATENT
PENDING

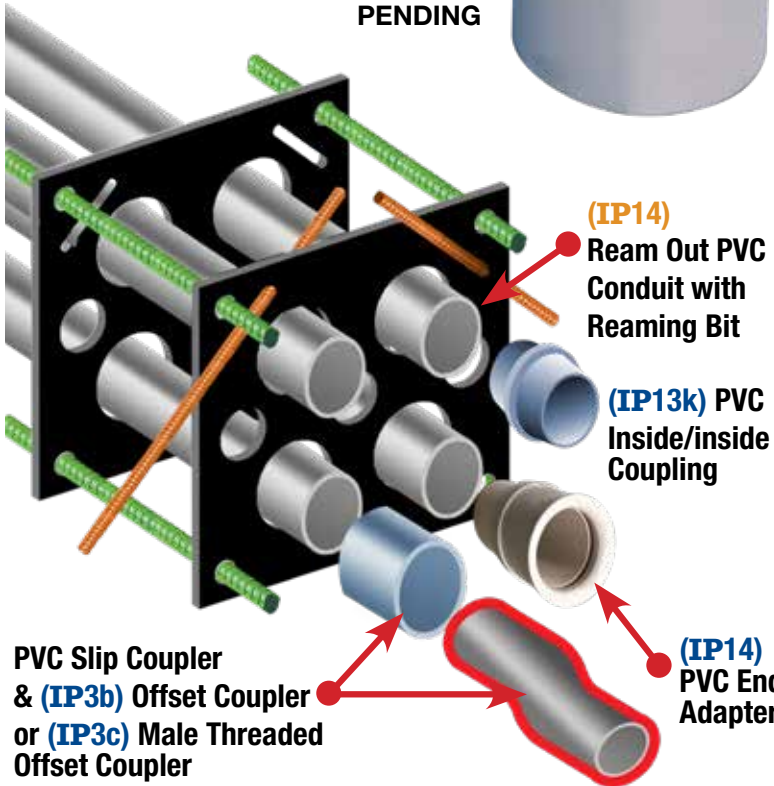

Conduit Sizes 1/2" thru 6"

Offset Sizing Chart & Catalog Numbers

Size	Offset	Cat #
1/2"	1/2"	50-PVC-OFFSET-THR 50
	3/4"	50-PVC-OFFSET-THR 75
	1"	50-PVC-OFFSET-THR 100
	1-1/4"	50-PVC-OFFSET-THR 125
	1-1/2"	50-PVC-OFFSET-THR 150
	2"	50-PVC-OFFSET-THR 200
	3"	50-PVC-OFFSET-THR 300
3/4"	1/2"	75-PVC-OFFSET-THR 50
	3/4"	75-PVC-OFFSET-THR 75
	1"	75-PVC-OFFSET-THR 100
	1-1/4"	75-PVC-OFFSET-THR 125
	1-1/2"	75-PVC-OFFSET-THR 150
	2"	75-PVC-OFFSET-THR 200
	3"	75-PVC-OFFSET-THR 300
1"	1/2"	100-PVC-OFFSET-THR 50
	3/4"	100-PVC-OFFSET-THR 75
	1"	100-PVC-OFFSET-THR 100
	1-1/4"	100-PVC-OFFSET-THR 125
	1-1/2"	100-PVC-OFFSET-THR 150
	2"	100-PVC-OFFSET-THR 200
	3"	100-PVC-OFFSET-THR 300
1-1/4"	1/2"	125-PVC-OFFSET-THR 50
	3/4"	125-PVC-OFFSET-THR 75
	1"	125-PVC-OFFSET-THR 100
	1-1/4"	125-PVC-OFFSET-THR 125
	1-1/2"	125-PVC-OFFSET-THR 150
	2"	125-PVC-OFFSET-THR 200
	3"	125-PVC-OFFSET-THR 300
1-1/2"	1/2"	150-PVC-OFFSET-THR 50
	3/4"	150-PVC-OFFSET-THR 75
	1"	150-PVC-OFFSET-THR 100
	1-1/4"	150-PVC-OFFSET-THR 125
	1-1/2"	150-PVC-OFFSET-THR 150
	2"	150-PVC-OFFSET-THR 200
	3"	150-PVC-OFFSET-THR 300
2"	1/2"	200-PVC-OFFSET-THR 50
	3/4"	200-PVC-OFFSET-THR 75
	1"	200-PVC-OFFSET-THR 100
	1-1/4"	200-PVC-OFFSET-THR 125
	1-1/2"	200-PVC-OFFSET-THR 150
	2"	200-PVC-OFFSET-THR 200
	3"	200-PVC-OFFSET-THR 300

Size	Offset	Cat #
3"	1/2"	300-PVC-OFFSET-THR 50
	3/4"	300-PVC-OFFSET-THR 75
	1"	300-PVC-OFFSET-THR 100
	1-1/4"	300-PVC-OFFSET-THR 125
	1-1/2"	300-PVC-OFFSET-THR 150
	2"	300-PVC-OFFSET-THR 200
	3"	300-PVC-OFFSET-THR 300
3-1/2"	1/2"	350-PVC-OFFSET-THR 50
	3/4"	350-PVC-OFFSET-THR 75
	1"	350-PVC-OFFSET-THR 100
	1-1/4"	350-PVC-OFFSET-THR 125
	1-1/2"	350-PVC-OFFSET-THR 150
	2"	350-PVC-OFFSET-THR 200
	3"	350-PVC-OFFSET-THR 300
4"	1/2"	400-PVC-OFFSET-THR 50
	3/4"	400-PVC-OFFSET-THR 75
	1"	400-PVC-OFFSET-THR 100
	1-1/4"	400-PVC-OFFSET-THR 125
	1-1/2"	400-PVC-OFFSET-THR 150
	2"	400-PVC-OFFSET-THR 200
	3"	400-PVC-OFFSET-THR 300
5"	1/2"	500-PVC-OFFSET-THR 50
	3/4"	500-PVC-OFFSET-THR 75
	1"	500-PVC-OFFSET-THR 100
	1-1/4"	500-PVC-OFFSET-THR 125
	1-1/2"	500-PVC-OFFSET-THR 150
	2"	500-PVC-OFFSET-THR 200
	3"	500-PVC-OFFSET-THR 300
6"	1/2"	600-PVC-OFFSET-THR 50
	3/4"	600-PVC-OFFSET-THR 75
	1"	600-PVC-OFFSET-THR 100
	1-1/4"	600-PVC-OFFSET-THR 125
	1-1/2"	600-PVC-OFFSET-THR 150
	2"	600-PVC-OFFSET-THR 200
	3"	600-PVC-OFFSET-THR 300

QwikDuct Templates can be used with all standardized trade size conduit specified per NFPA 70 NEC



PATENT PENDING
PATENTED



LABELS APPLY TO PRODUCTS ONLY WHERE SHOWN ABOVE

730 Pratt Boulevard • Elk Grove Village, IL 60007
P: (847) 593-8595 • F: (847) 593-8629 • Toll-free (800) 233-8595
E: info@spproducts.com • www.spproducts.com

IP3c

PVC Running Thread for PVC Conduit SCH 40/80



NEW

Patent
Pending



- Any size Running Thread PVC Conduit SCH 40/80 up to 30 inches in length for 1/2" thru 6" conduit
- Use with PVC Female adapter or locknut for any type of conduit application
- Or order several 30" PVC Running Thread Conduits and cut to desired length on the jobsite

SIZE	LENGTH	CATALOG #
1/2"	Specify	PVN-50-40
3/4"	Specify	PVN-75
1"	Specify	PVN-100
1-1/4"	Specify	PVN-125
1-1/2"	Specify	PVN-150
2"	Specify	PVN-200
3"	Specify	PVN-300
3-1/2"	Specify	PVN-350
4"	Specify	PVN-400
5"	Specify	PVN-500
6"	Specify	PVN-600

SIZE	LENGTH	CATALOG #
1/2"	Specify	PVN-50-80
3/4"	Specify	PVN-75
1"	Specify	PVN-100
1-1/4"	Specify	PVN-125
1-1/2"	Specify	PVN-150
2"	Specify	PVN-200
3"	Specify	PVN-300
3-1/2"	Specify	PVN-350
4"	Specify	PVN-400
5"	Specify	PVN-500
6"	Specify	PVN-600

SP PRODUCTS, INC
Productivity and value thru ideas



PATENT PENDING
PATENTED



LABELS APPLY TO PRODUCTS ONLY WHERE SHOWN ABOVE

730 Pratt Boulevard • Elk Grove Village, IL 60007
P: (847) 593-8595 • F: (847) 593-8629 • Toll-free (800) 233-8595
E: info@spproducts.com • www.spproducts.com

IP3d

Split Steel Nuts

Save valuable time placing the nut at desired position instead of spinning the nut up long lengths of threaded rod to final location.

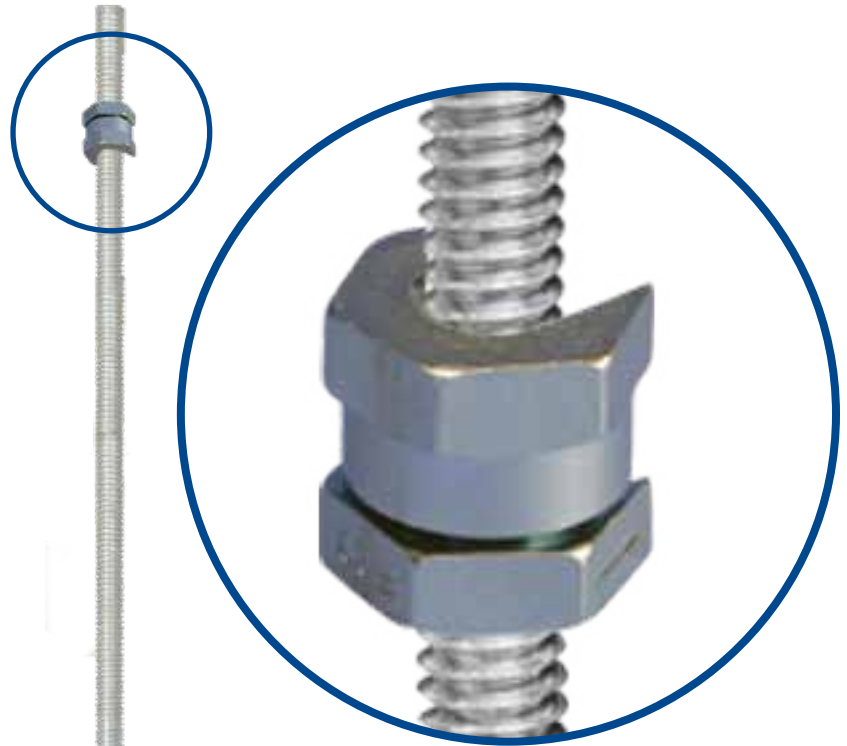

Cat#	Desc.
SN25	1/4"
SN38	3/8"
SN50	1/2"

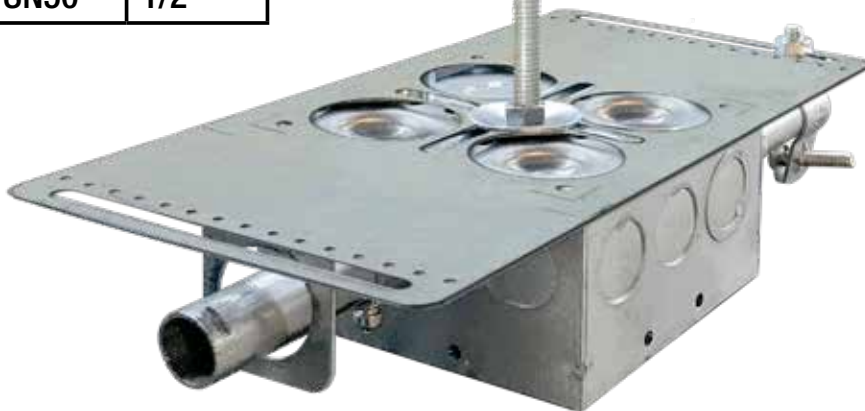

SP PRODUCTS, INC
Productivity and value thru ideas



PATENT PENDING
PATENTED



LABELS APPLY TO PRODUCTS ONLY WHERE SHOWN ABOVE

730 Pratt Boulevard • Elk Grove Village, IL 60007
P: (847) 593-8595 • F: (847) 593-8629 • Toll-free (800) 233-8595
E: info@spproducts.com • www.spproducts.com

IP4



“THE ORIGINAL” Box Support Plate

SAVE MORE THAN 30 MINUTES PER INSTALL WITH LESS MATERIAL

Meets NEC 3 Foot Rule From Only One Support

2 Way

Cat#	2-Way Desc.	Wt. Ea.	Qty/Box
CSP-1 (SS)	4" x 12" 16 Gauge Galvanized or Stainless Steel	0.8 lbs.	50

1/4" slots for nuts and bolts to install clamps facing down to support up thru 1 1/4" conduit and flex or equal size MC Cable entering all four sides at any KO location...

or facing up for larger conduit overhead.

ADDITIONAL BENEFITS

1/4" slots to move plate

Install up thru 1/2" threaded rod

**SAVE
MORE THAN
30 MINUTES
PER INSTALL WITH
LESS MATERIAL**

Load rating of conduit and box support plates is associated with load rating of box and mounting hardware

Plates also available as complete assemblies with any configuration of components (boxes, connectors, etc.)

Install larger conduit overhead with our patented 3 conduit threaded block support. Block also sold separately (see IP21a)

Half

Cat#	1/2 Desc.	Wt. Ea.	Qty/Box
CSP-1/2 (SS)	4" x 6" 16 Gauge Galvanized or Stainless Steel	0.4 lbs.	50

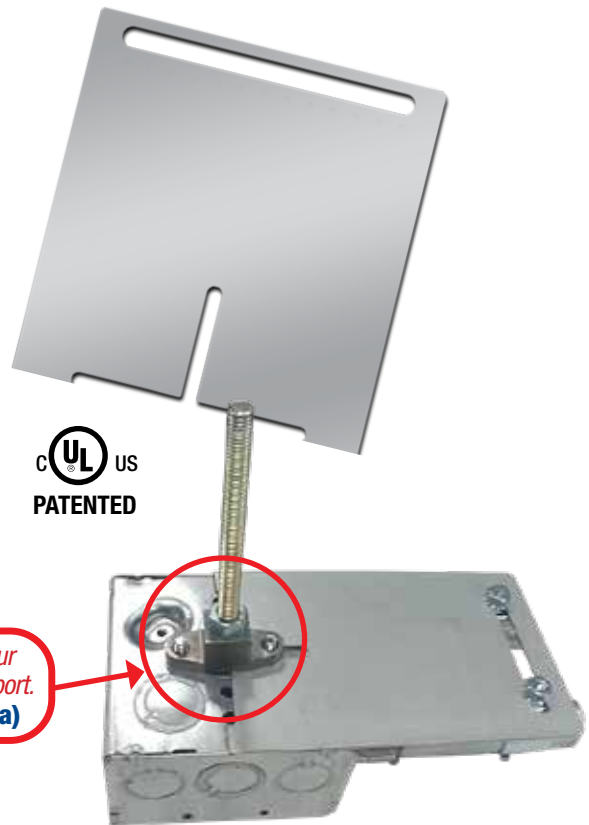

UL US
PATENTED



UL US
PATENTED

For all types of raceways installed per NEC. Accept 4 or 4 1/16 inch square shallow or deep boxes. If shallow (1 1/2 inch deep) Maximum size = 3/4 inch conduit or equal size flexible conduit or MC Cable entering box.

Suitable for 1/4, 3/8 or 1/2 inch rod for support.

Customer must satisfy all codes and owners' specifications.



**PATENT PENDING
PATENTED**



LABELS APPLY TO PRODUCTS ONLY WHERE SHOWN ABOVE

730 Pratt Boulevard • Elk Grove Village, IL 60007
P: (847) 593-8595 • F: (847) 593-8629 • Toll-free (800) 233-8595
E: info@spproducts.com • www.spproducts.com

IP5-5a

4-WAY BOX SUPPORT

SAVE UP TO 1 HOUR
PER INSTALLATION
WITH LESS MATERIAL



**Meets
NEC 3 Foot Rule
From Only
One Support**

SEE WEBSITE
VIDEO **IP-1**

4 Way

Cat#	4-Way Desc.	Wt. Ea.	Qty/Box
CSP-4W-WC (SS)	9-5/8" x 9-5/8" 18 Gauge Galvanized or Stainless Steel (SS)	0.7 lbs.	25

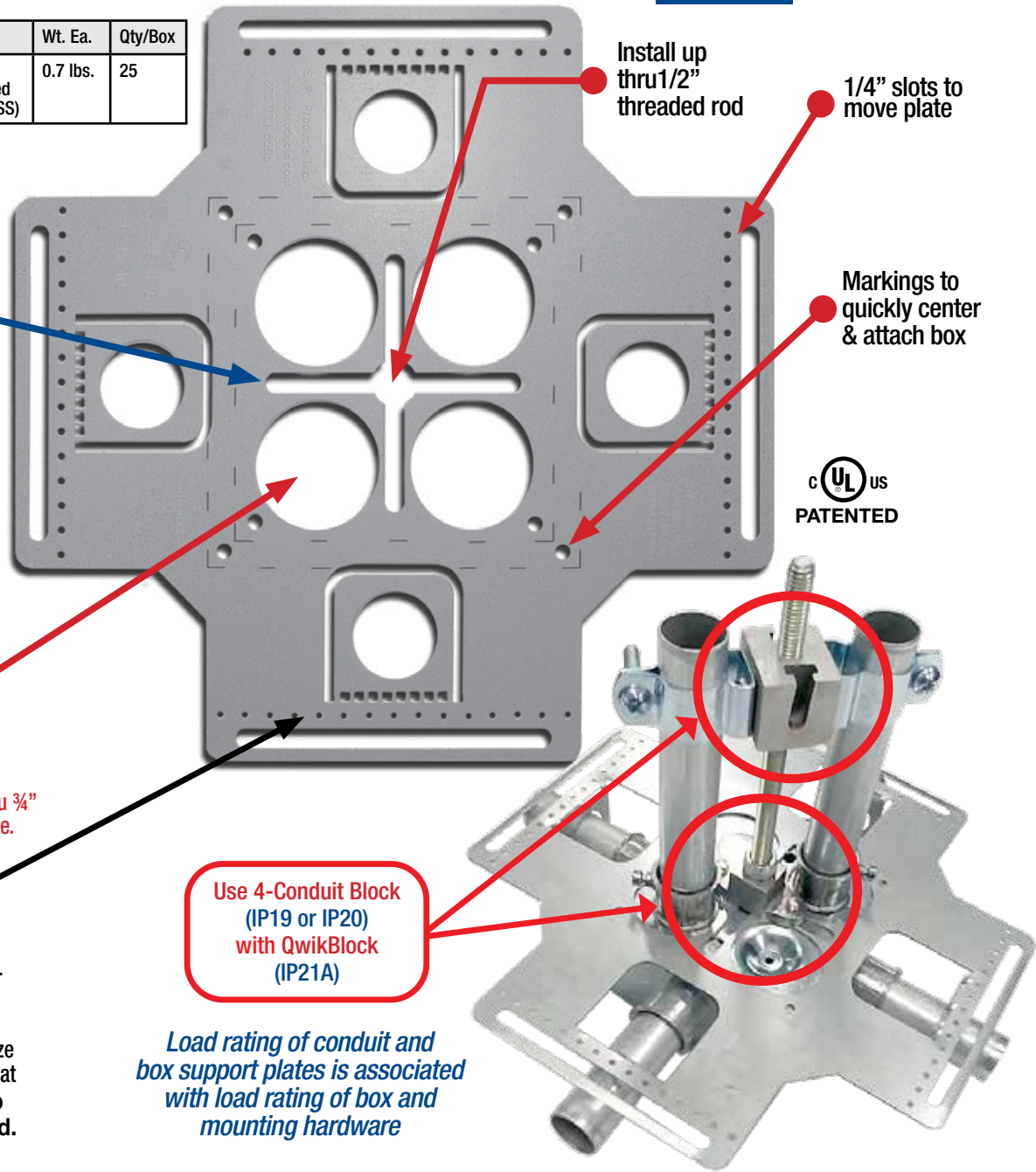

1
Eliminate center KO clamps for up thru 3/4" Conduit, Flex or equal size MC Cable entering all 4 sides of box at center KO location only. Bend tabs down, feed raceways thru openings to connectors on box. Holes for tek screws are also provided to attach conduit clamps when entering all other KO locations.

2
4 large open KOs in center allow entering back of box with up thru 3/4" raceways to save even more time.

3
Tek screw holes and 1/4" slots for nuts and bolts to install clamps facing down to support up thru 1 1/4" conduit and flex or equal size MC Cable entering all four sides at any KO location... or facing up for larger conduit overhead.

Use 4-Conduit Block (IP19 or IP20) with QwikBlock (IP21A)

Load rating of conduit and box support plates is associated with load rating of box and mounting hardware



SP PRODUCTS, INC
Productivity and value thru ideas



PATENT PENDING
PATENTED



LABELS APPLY TO PRODUCTS ONLY WHERE SHOWN ABOVE

730 Pratt Boulevard • Elk Grove Village, IL 60007
P: (847) 593-8595 • F: (847) 593-8629 • Toll-free (800) 233-8595
E: info@spproducts.com • www.spproducts.com

IP6

2-WAY BOX SUPPORT



Cat#	2-Way Desc.	Wt. Ea.	Qty/Box
CSP-2W-WC (SS)	4-3/4" x 9-5/8" 18 Gauge Galvanized or Stainless Steel (SS)	0.5 lbs.	50
Cat#	2-Way 1/2 Desc.	Wt. Ea.	Qty/Box
CSP-1/2-WC (SS)	4-3/4" x 4-13/16" 18 Gauge Galvanized or Stainless Steel (SS)	0.25 lbs.	100

Plates also available as complete assemblies with any configuration of components (boxes, connectors, etc.)

**Meets
NEC 3 Foot Rule
From Only
One Support**

Load rating of conduit and box support plates is associated with load rating of box and mounting hardware

Eliminate center KO clamps for up thru 3/4" Conduit, Flex or equal size MC Cable entering all both sides of box at center KO location only.



Use 4-Conduit Block (IP19 or IP20) with QwikBlock (IP21A)

**For all types of raceways installed per NEC.
Accepts 4 or 4^{11/16} & 5" inch square shallow or deep boxes.
If shallow (1 1/2 inch deep) Maximum size = 3/4 inch conduit or equal size flexible conduit or MC Cable entering box.
Suitable for 1/4, 3/8 or 1/2 inch rod for support.**



**PATENT PENDING
PATENTED**



LABELS APPLY TO PRODUCTS ONLY WHERE SHOWN ABOVE

730 Pratt Boulevard • Elk Grove Village, IL 60007
P: (847) 593-8595 • F: (847) 593-8629 • Toll-free (800) 233-8595
E: info@spproducts.com • www.spproducts.com

IP6a

"ORIGINAL ROUND" Box Support Plate



**SAVE
MORE THAN
30 MINUTES PER
INSTALLATION**



Cat#	4-Way Desc.	Wt. Ea.	Qty/Box
CSPR (SS)	11-3/4" Diameter 20 Gauge Galvanized or Stainless Steel (SS)	1 lb.	25

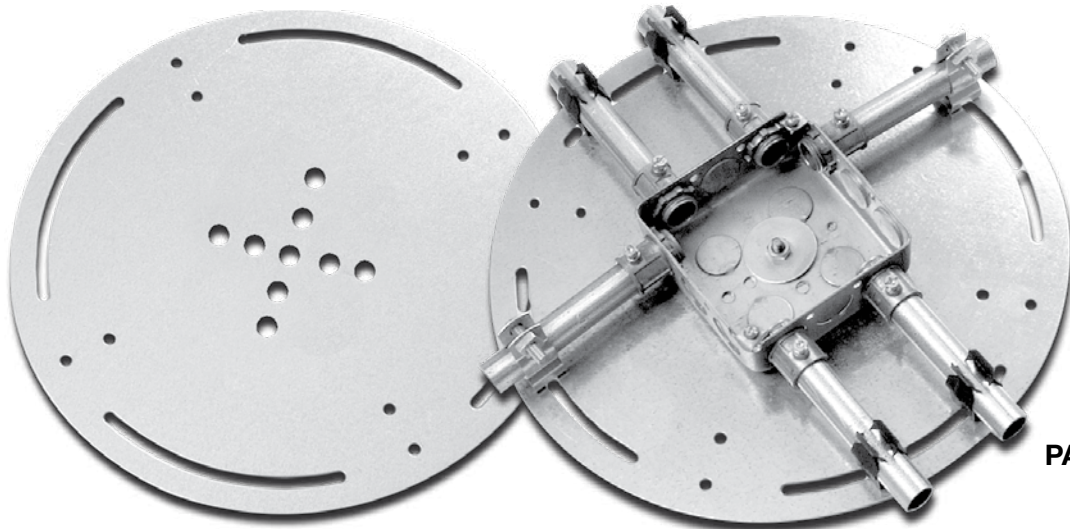

PATENTED

MODIFIED ROUND Box Support Plate

Cat#	4-Way Desc.	Wt. Ea.	Qty/Box
CSPR-4KO (SS)	11-3/4" Diameter 20 Gauge Galvanized or Stainless Steel (SS)	1 lb.	25

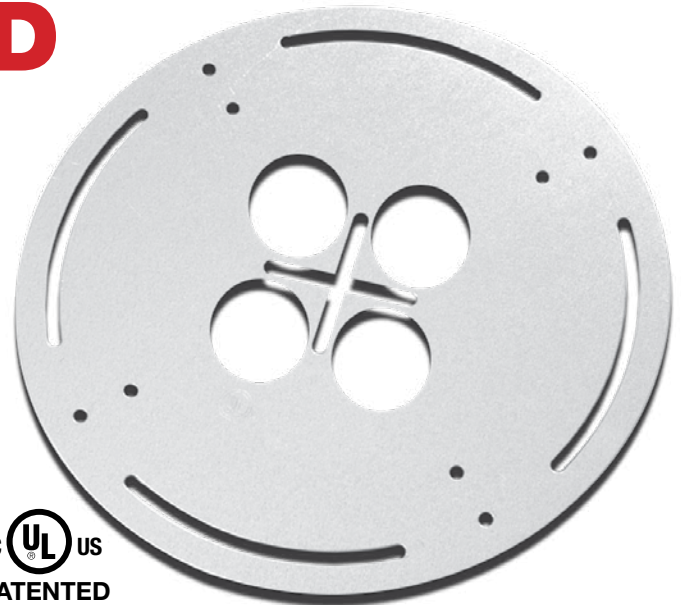

PATENTED

4 large open KOs in center allow entering back of box with up thru 3/4" raceways to save even more time.

Plates Suitable for 4, 4-11/16, 5 inch Square Plus up thru 8 x 8 inch Junction Boxes Mounted Either Horizontally or Vertically. 3/32" Holes for Self Tappers and 1/4" Wide Open Slot at Each End Allow Fastening Clamps for Conduit Supports at any KO center.

Assemblies Complete with Box, Connectors, Rod, "Econo-Whips" etc. Attached Available.

Load rating of conduit and box support plates is associated with load rating of box and mounting hardware



PATENT PENDING
PATENTED



LABELS APPLY TO PRODUCTS ONLY WHERE SHOWN ABOVE

730 Pratt Boulevard • Elk Grove Village, IL 60007
P: (847) 593-8595 • F: (847) 593-8629 • Toll-free (800) 233-8595
E: info@spproducts.com • www.spproducts.com

IP6b

UNIVERSAL ROUND MADE IN USA

Box Support Plate

Cat#	4-Way Desc.	Wt. Ea.	Qty/Box
UCSPR-WC-4KO (SS)	11-3/4" Diameter 20 Gauge Galvanized or Stainless Steel (SS)	1.5 lbs	25

ADDITIONAL BENEFITS

- 1/4" slots to position plate if required
- Mount horizontally up thru 1/2" threaded rod
- Markings to quickly center and attach box
- Bend down tabs to mount vertically with up thru 1/2" threaded rod

Install larger conduit overhead with our patented 4 conduit threaded block support. Block also sold separately (see IP19)

Load rating of conduit and box support plates is associated with load rating of box and mounting hardware

SAVE MORE THAN 30 MINUTES PER INSTALLATION

1 Eliminates center KO clamps for up thru 3/4" Conduit, Flex or equal size MC Cable entering all 4 sides of box at any KO location. Bend tabs down, feed raceways thru openings to connectors on box.

2 4 large open KOs in center allow entering back of box with up thru 3/4" raceways to save even more time.

3 Tek screw holes and 1/4" slots for nuts and bolts to install clamps facing down to support up thru 1 1/4" conduit and flex or equal size MC Cable entering all four sides at any KO location...or facing up for larger conduit overhead.

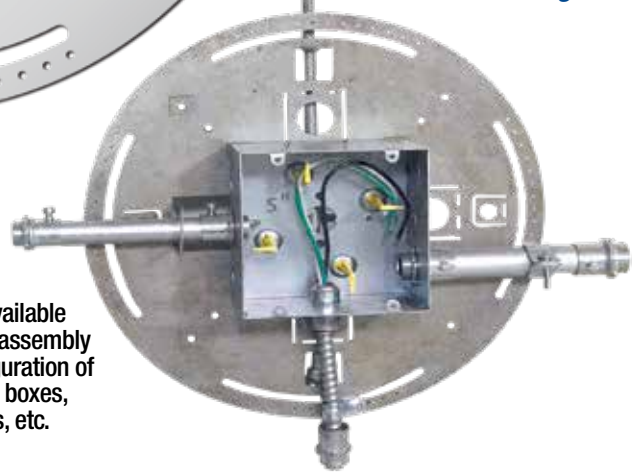
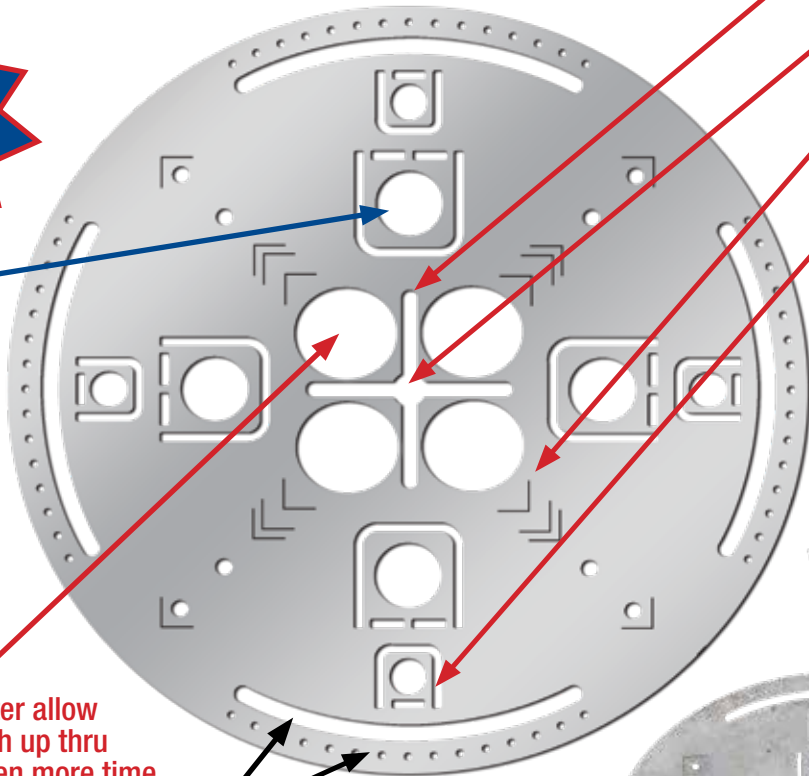

Plate also available as a complete assembly with any configuration of components boxes, connectors, etc.

ALL FROM ONLY ONE SUPPORT HORIZONTALLY OR VERTICALLY

For all types of raceways installed per NEC.

Accepts 4, 4^{11/16}, 5 inch square shallow or deep boxes and 6 x 6 & 8 x 8 inch junction boxes.
If shallow (1 1/2 inch deep) Maximum size = 3/4 inch conduit or equal size flexible conduit or MC Cable entering box. Suitable for 1/4, 3/8 or 1/2 inch rod for support.



PATENT PENDING
PATENTED



LABELS APPLY TO PRODUCTS ONLY WHERE SHOWN ABOVE

730 Pratt Boulevard • Elk Grove Village, IL 60007
P: (847) 593-8595 • F: (847) 593-8629 • Toll-free (800) 233-8595
E: info@spproducts.com • www.spproducts.com

IP6c

2-WAY BOX SUPPORT PLATES with FINGERS



Cat#	2-Way Desc.	Wt. Ea.	Qty/Box
CSPV-2W-FC (SS)	5" x 11-1/2" 18 Gauge Galvanized or Stainless Steel (SS)	0.5 lbs.	50
Cat#	2-Way 1/2 Desc.	Wt. Ea.	Qty/Box
CSPV-1W-FC (SS)	5" x 5-3/4" 18 Gauge Galvanized or Stainless Steel (SS)	0.25 lbs.	100

**SAVE OVER
HALF HOUR
PER INSTALL WITH
LESS MATERIAL**

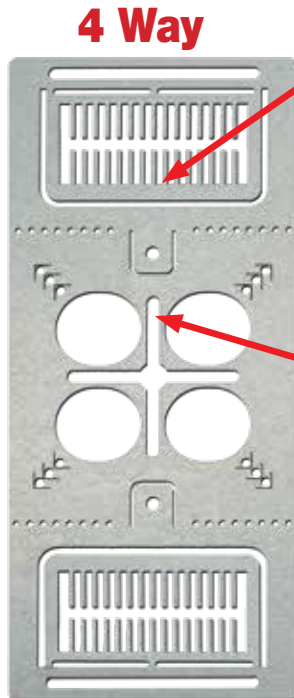

4 Way

1
For vertical application bend 2 smaller tabs out and insert 1/4", 3/8" or 1/2" rod secured with nuts for vertical support.



2
OR insert rod in fixed hole of plate and secure with Qwik Block (IP21A) to automatically center with either a 1/4" or 3/8" threaded rod with punching a center KO on top of box.

18 Gauge Galvanized or Stainless Steel

Use 4-Conduit Block (IP19 or IP20) with QwikBlock (IP21A)

4 Way-Half



18 Gauge Galvanized or Stainless Steel

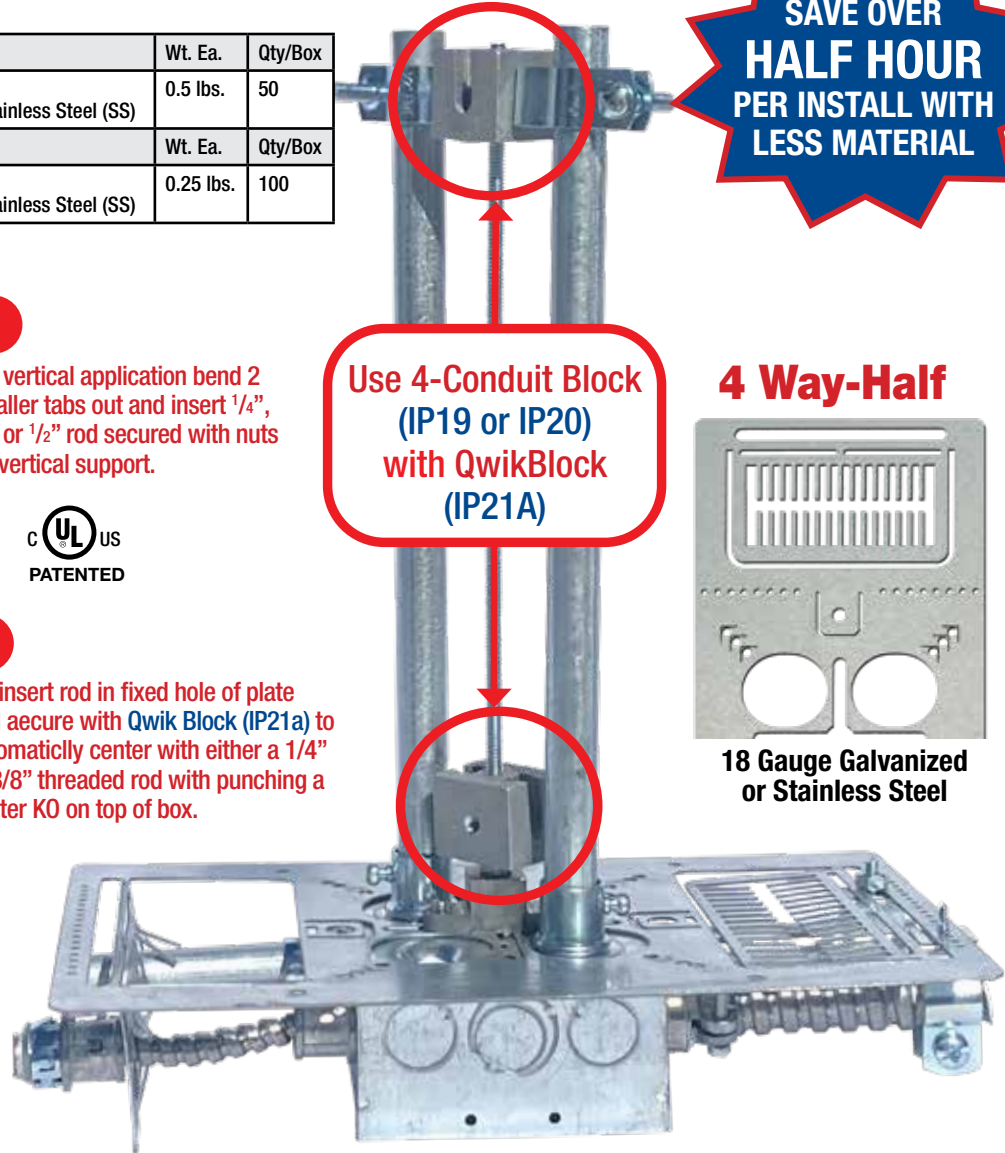

Load rating of conduit and box support plates is associated with load rating of box and mounting hardware.

Fingers eliminate all clamps for up thru 1 1/4" conduit, flex or equal size MC Cable entering any KO location 1 or 2 sides of box.

Plates also available as a complete assembly with any configuration of components boxes, connectors, etc.

For all types of raceways installed per NEC.
Accept 4, 4 11/16, 5 inch square shallow or deep boxes. If shallow (1 1/2 inch deep)
Maximum size = 3/4 inch conduit or equal size flexible conduit or MC Cable entering box.
Suitable for 1/4, 3/8 or 1/2 inch rod for application.



**PATENT PENDING
PATENTED**



LABELS APPLY TO PRODUCTS ONLY WHERE SHOWN ABOVE

730 Pratt Boulevard • Elk Grove Village, IL 60007
P: (847) 593-8595 • F: (847) 593-8629 • Toll-free (800) 233-8595
E: info@spproducts.com • www.spproducts.com

IP6d



4-WAY BOX SUPPORT PLATE with Split Fingers for Horizontal or Vertical Installation

**SAVE OVER
1 HOUR
PER INSTALL
WITH LESS
MATERIAL**

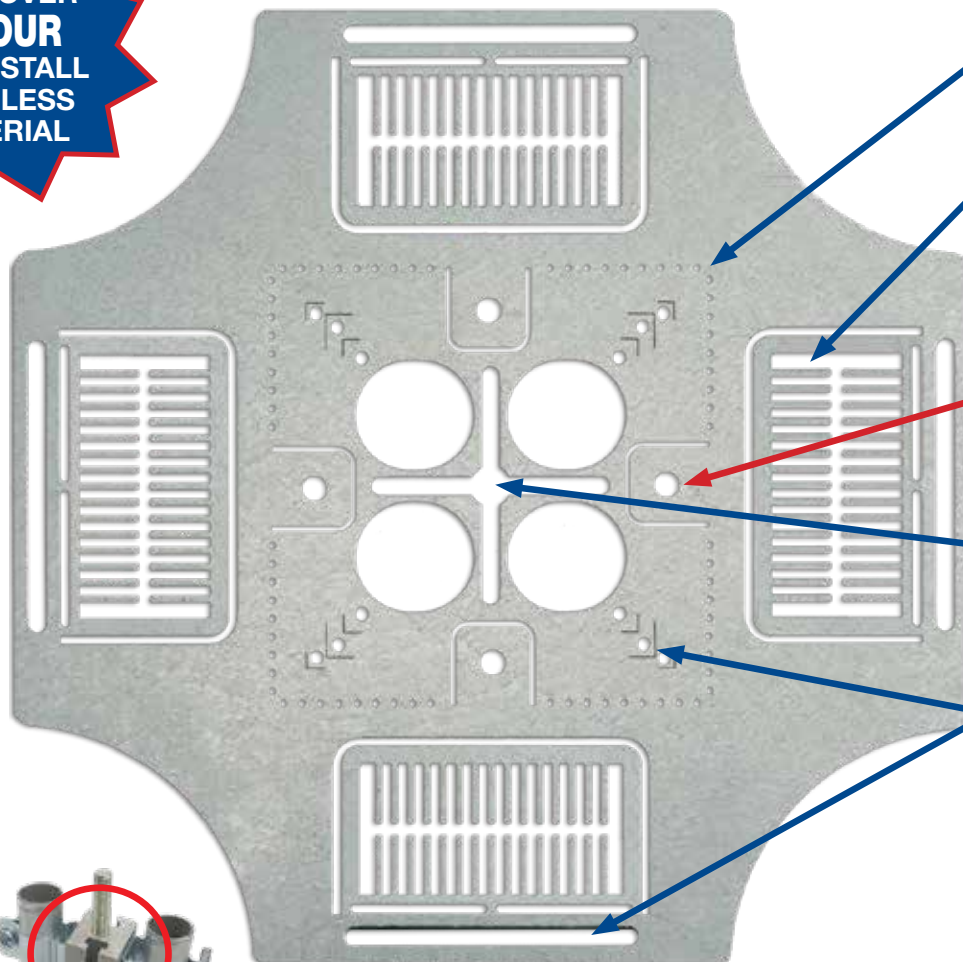

- 1** Used with 4", 4 1/2" or 5" square outlet plus 6 x 6 and 8 x 8 junction boxes.
- 2** Eliminates ALL conduit clamps. Bend large tabs with split fingers out and feed up thru 1/4" conduit or equal O.D. McCable into box at any KO location on all 4 sides of box.
- 3** Bend 4 smaller tabs out and insert 1/4", 3/8", or 1/2" rod secured with nuts for vertical support.
- 4** OR insert rod in fixed center hole of plate and also secure with our QWIK BLOCK (IP21a) for horizontal support.
- 5** 1/4" slots for fastening conduit clamps to plate with nuts and bolts plus holes for TEK screws if required. 1/4" slots and TEK screw holes allow conduit for other systems to be supported above the plate for even greater savings!

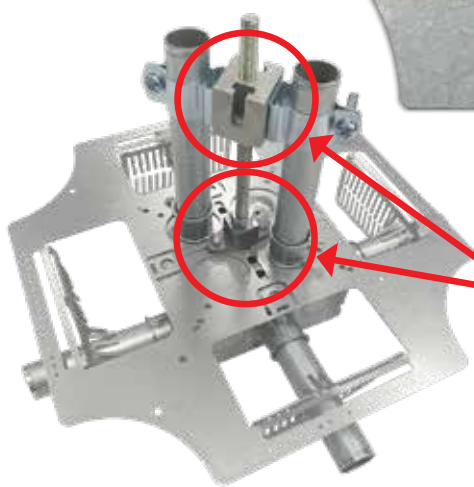

UL US PATENT PENDING

Use 4-Conduit Block (IP19 or IP20) with QwikBlock (IP21A)

Cat#	2-Way Desc.	Wt. Ea.	Qty/Box
CSPV-4W-FC (SS)	11-1/2" x 11-1/2" 18 Gauge Galvanized or Stainless Steel (SS)	0.75 lbs.	25



PATENT PENDING
PATENTED



LABELS APPLY TO PRODUCTS ONLY WHERE SHOWN ABOVE

730 Pratt Boulevard • Elk Grove Village, IL 60007
P: (847) 593-8595 • F: (847) 593-8629 • Toll-free (800) 233-8595
E: info@spproducts.com • www.spproducts.com

IP7

Junction Box Support Plates



20" x 20" Supports Up Thru 12" x 12" J Box
28" x 28" Supports Up Thru 20" x 20" J Box

Mount Horizontally or Vertically from 1 single support

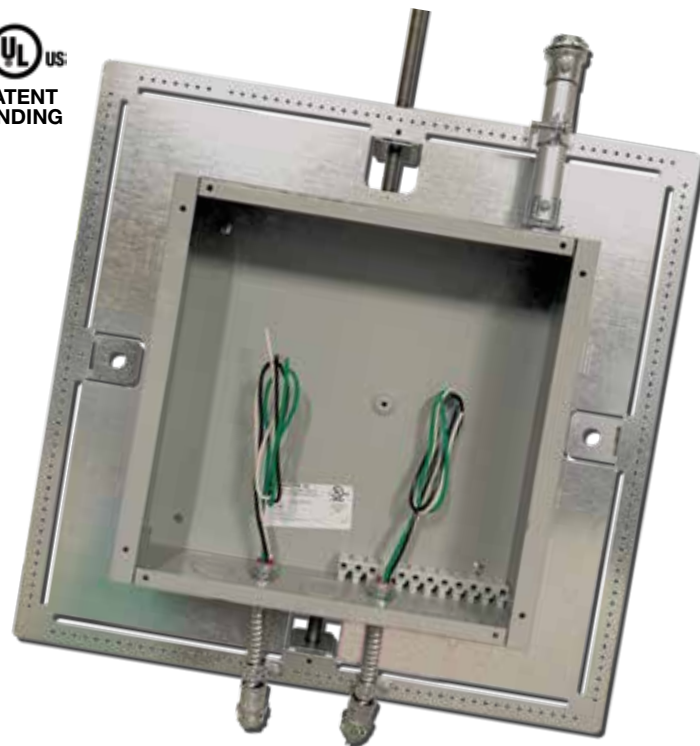

Bend down four tabs at centers of outer edges to accept up thru 1/2" rod for vertical installation.

Drill hole in center of back of box to allow attaching single support through open cross on 20 x 20 plate to mount horizontally.

4 open KO's in center of plate allow conduit or MC Cable to enter and leave back of box.

Load rating of conduit and box support plates is associated with load rating of box and mounting hardware

20 x 20 Plate installed horizontally by one single support from ceiling eliminating additional supports for box and conduits entering box.



Cat#	Desc.	Wt. Ea.	Qty/Box
CSP20x20	20" x 20" 16 Gauge Galvanized or Stainless Steel (SS)	7.3 lbs	8
CSP28x28	28" x 28" 16 Gauge Galvanized or Stainless Steel (SS)	14 lbs	Any Qty.

- 1/4" Slots & Tek screw holes provided to install clamps at any location
- Other Dimensions for Smaller/Larger Boxes available, Consult Factory



PATENT PENDING
PATENTED



LABELS APPLY TO PRODUCTS ONLY WHERE SHOWN ABOVE

730 Pratt Boulevard • Elk Grove Village, IL 60007
P: (847) 593-8595 • F: (847) 593-8629 • Toll-free (800) 233-8595
E: info@spproducts.com • www.spproducts.com

IP8

Grid-System Box Support Plate

For Medical Centers, Hospital Rooms Requiring Power & Lighting, Emergency Power, & Alarms

**SAVE OVER
2 HOURS
Per Installation**

Cat#	Desc.	Wt. Ea,	Qty/Box
CSPDualJB	19-1/2" x 19-1/2" 16 Gauge Galvanized or Stainless Steel (SS)	7.3 lbs	Any Qty.

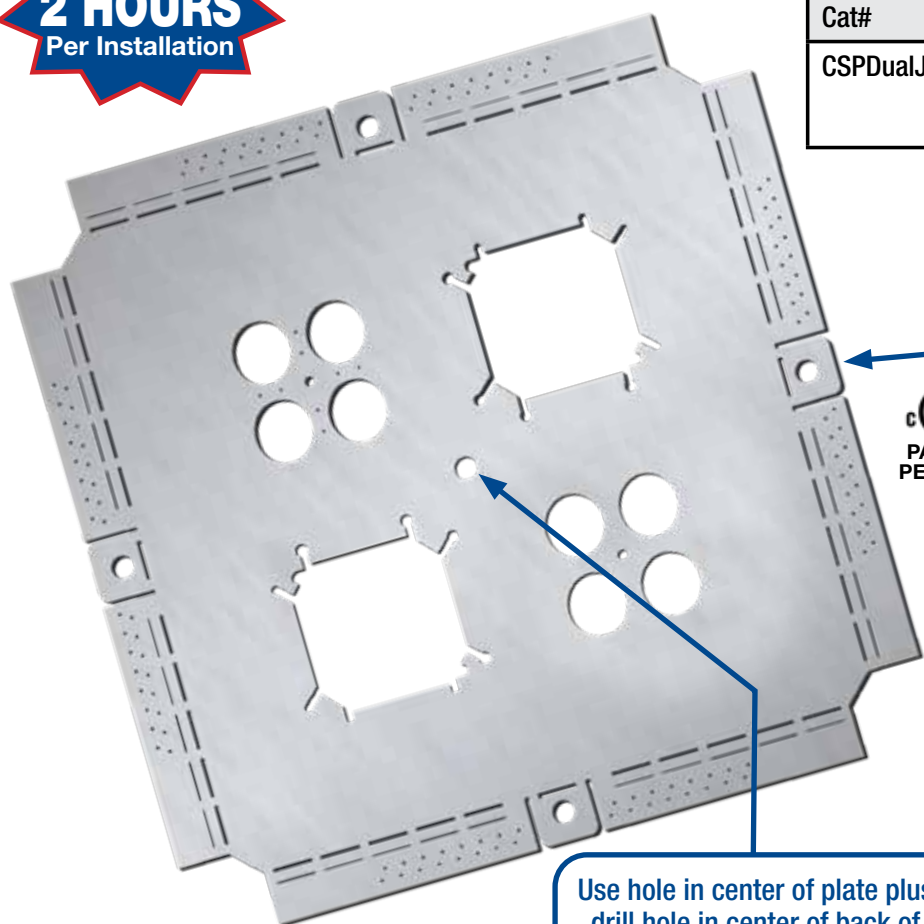

For vertical mounting bend tabs back on reverse side and support with up thru 1/2" rod

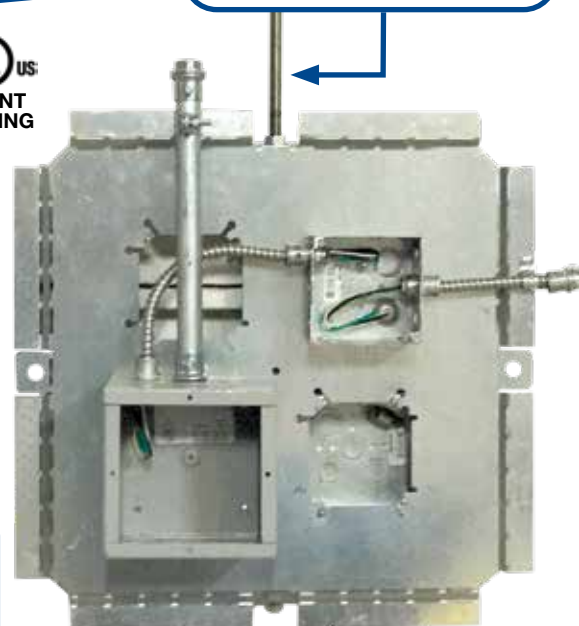

Vertical Installation Shown

Use hole in center of plate plus drill hole in center of back of junction box to allow mounting plates horizontally.

Load rating of conduit and box support plates is associated with load rating of box and mounting hardware

Mount Horizontally or Vertically from 1 single support

- Accepts 4", 4¹/₁₆", & 5" square boxes up thru 12" x 12" junction boxes.
- Mount two or more systems on same plate without cable and boxes interfering with each other.
- Allows faster, easier trouble shooting and organizing systems on jobs.
- 4 Large elliptical holes allow lining up box & plate for fast easy access in/out back of the box.
- Mount boxes above & below the plate when is installed horizontally.



PATENT PENDING
PATENTED



LABELS APPLY TO PRODUCTS ONLY WHERE SHOWN ABOVE

730 Pratt Boulevard • Elk Grove Village, IL 60007
P: (847) 593-8595 • F: (847) 593-8629 • Toll-free (800) 233-8595
E: info@spproducts.com • www.spproducts.com

IP8a



Roof Top Blox

Roof Conduit Support

Safer, Lighter and Faster!

Also Available with Various Lengths of Galvanized Steel Strut Attached

EXTREMELY COMPETITIVE PRICING

Eliminates cutting and hauling, expensive treated lumber or heavy rubberized supports up to roof.

- Recycled black plastic. Can qualify for LEED Credits.
- Quickly secure conduit with an inexpensive one hole strap.
- Block floats free on roof. Allows movement to prevent damage to roof membrane when conduit expands and contracts due to temperature changes.
- Single Point load rating 250 lbs. or Dual Point/Strut Mounted 350 lb. load rating.
- Perfect for gas piping, plumbing, HVAC, conduit, cable tray & mechanical equipment.

Reinforced Starter Guides For #12/#14 Screws

Pipe Saddles Along Top Edges

Removable Perforated Strap

2 X Extension Rod Hole for 1/2" Rod

3 X Extension Rod Hole for 3/8" Rod

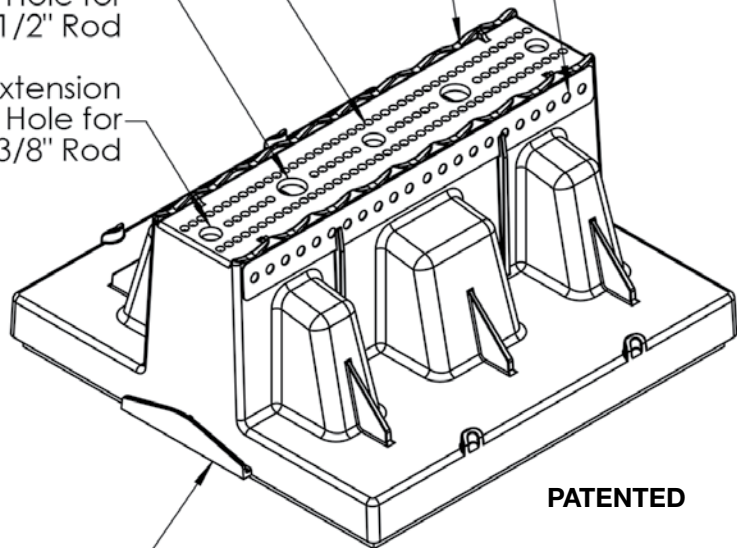

PATENTED

Interlocking End-to-End Tabs

Cat#	Desc.
RTB-2000	Roof Top Blox

Single Point 250 lb. Load Rating

Also Available with Various Lengths of Any Type Strut Attached

For Electrical, Plumbing, HVAC, etc.



PATENT PENDING
PATENTED



LABELS APPLY TO PRODUCTS ONLY WHERE SHOWN ABOVE

730 Pratt Boulevard • Elk Grove Village, IL 60007

P: (847) 593-8595 • F: (847) 593-8629 • Toll-free (800) 233-8595

E: info@spproducts.com • www.spproducts.com

IP9

Nylon Wrap-Around Conduit Straps



Quickly & Firmly Secure Conduit in Seconds

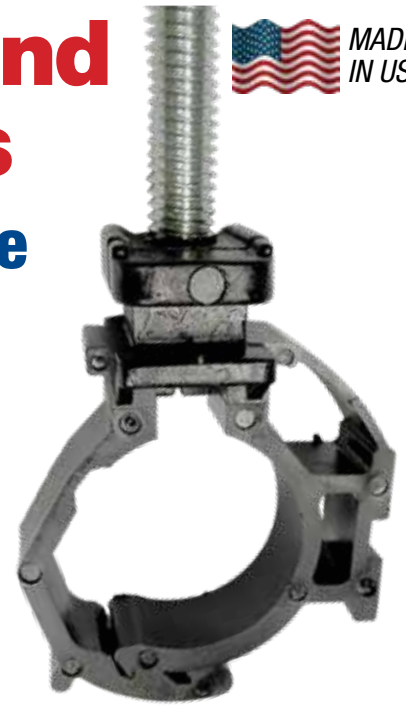

- No Tools Required
- Flame Retardant
- Up Thru 950 lb Load Ratings
- Plenum Rated Up Thru 1½" Size

CAT #	ELECTRICAL			Max Load lbs.
	EMT	Heavy Wall	IMC	
SPP-12-16P	N/A	N/A	N/A	170
SPP-17-20P	1/2" (.706)	N/A	N/A	195
SPP-21-24P	3/4" (.922)	1/2" (.840)	1/2" (.815)	215
SPP-25-29P	N/A	3/4" (1.050)	3/4" (1.029)	315
SPP-30-34P	1" (1.163)	1" (1.315)	1" (1.290)	320
SPP-35-38P	1-1/4" (1.510)	N/A	N/A	342

CAT #	ELECTRICAL			Max Load lbs.
	EMT	Heavy Wall	IMC	
SPP-40-44P	1-1/2" (1.740)	1-1/4" (1.660)	1-1/4" (1.638)	365
SPP-48-54P	N/A	1-1/2" (1.900)	1-1/2" (1.883)	380
SPP-56-63P	2" (2.197)	2" (2.375)	2" (2.360)	410
SPP-66-76P	2-1/2" (2.875)	2-1/2" (2.875)	2-1/2" (2.857)	500
SPP-79-93P	3" (3.500)	3" (3.500)	3" (3.476)	600
SPP-101-115P	3½ & 4" (4.500)	4" (4.500)	4" (4.466)	950

NOTE: Fractional numbers reflect nominal pipe diameter, decimal numbers actual O.D. in inches.

Also Ideal for HVAC, Plumbing & Mechanical Installations



PATENT PENDING
PATENTED



LABELS APPLY TO PRODUCTS ONLY WHERE SHOWN ABOVE

730 Pratt Boulevard • Elk Grove Village, IL 60007
 P: (847) 593-8595 • F: (847) 593-8629 • Toll-free (800) 233-8595
 E: info@spproducts.com • www.spproducts.com

IP10



Trapeze Brackets



Eliminates 5 Conduit Clamps per Foot PLUS Support Rods, Conduit Straps, etc.



- For 1/4" or 3/8" Threaded Rod.
- Meets UL 2239 & CSA C22.2 No.18.4
- Galvanized or Stainless Steel (plus other gauges available)

Original Feed Thru 5 Conduits per foot

Plastic Bushings for pulling LV, MC Cable, etc. must be UL Listed to maintain UL Listing when installed in the field or SP factory.



- 1 foot thru 6 foot pieces
- Order in 1 ft. increments
- 5 openings per foot spaced 2 1/4" on center

Original EZUTB - Size 1/2" thru 1 1/4" Conduit or equal size MC Cable

Trapeze Brackets Wt. 0.56 lbs per foot 1/2" thru 1-1/4"	
Size	5 Conduits Catalog #
12"	EZUTB12-16GS (SS)
24"	EZUTB24-16GS (SS)
36"	EZUTB36-16GS (SS)
48"	EZUTB48-16GS (SS)
60"	EZUTB60-16GS (SS)
72"	EZUTB72-16GS (SS)
16GS = 16 Gauge Galvanized Steel (SS) = 302 Stainless Steel	

Feed Thru 6 Conduits per foot



- Accomodates maximum number of 1/2" or 1" Conduit or equal size MC Cable to fit the width of the panel can.
- Maximizes straight runs and minimizes the 90° installations

Trapeze Brackets Wt. 0.56 lbs per foot 1/2" thru 1"	
Size	6 Conduits Catalog #
12"	EZUTB75/100-12-16GS (SS)
24"	EZUTB75/100-24-16GS (SS)
36"	EZUTB75/100-36-16GS (SS)
48"	EZUTB75/100-48-16GS (SS)
60"	EZUTB75/100-60-16GS (SS)
72"	EZUTB75/100-72-16GS (SS)
16GS = 16 Gauge Galvanized Steel (SS) = 302 Stainless Steel	

Feed Thru 8 or 4 Conduits per foot



- Accomodates maximum number of 1/2" or 2" Conduit or equal size MC Cable.

Trapeze Brackets 1/2" thru 2"	
Size	4 Conduits Catalog #
12"	EZUTB200-12-14GS
Size	8 Conduits Catalog #
24"	EZUTB200-24-14GS
14GS = 14 Gauge Galvanized Steel	



PATENT PENDING
PATENTED



LABELS APPLY TO PRODUCTS ONLY WHERE SHOWN ABOVE

730 Pratt Boulevard • Elk Grove Village, IL 60007
P: (847) 593-8595 • F: (847) 593-8629 • Toll-free (800) 233-8595
E: info@spproducts.com • www.spproducts.com

IP11

383 lb
Load Rating

Trapeze Brackets



Stack Overhead in Tight Areas



Vertical on Walls

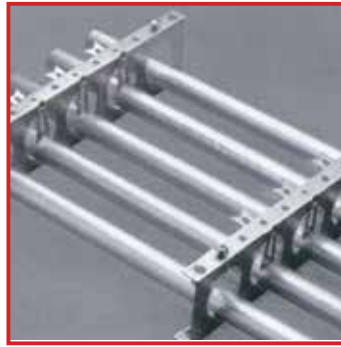

on Decks



Attach Conduit/Box Support Plates Above & Below Conduit

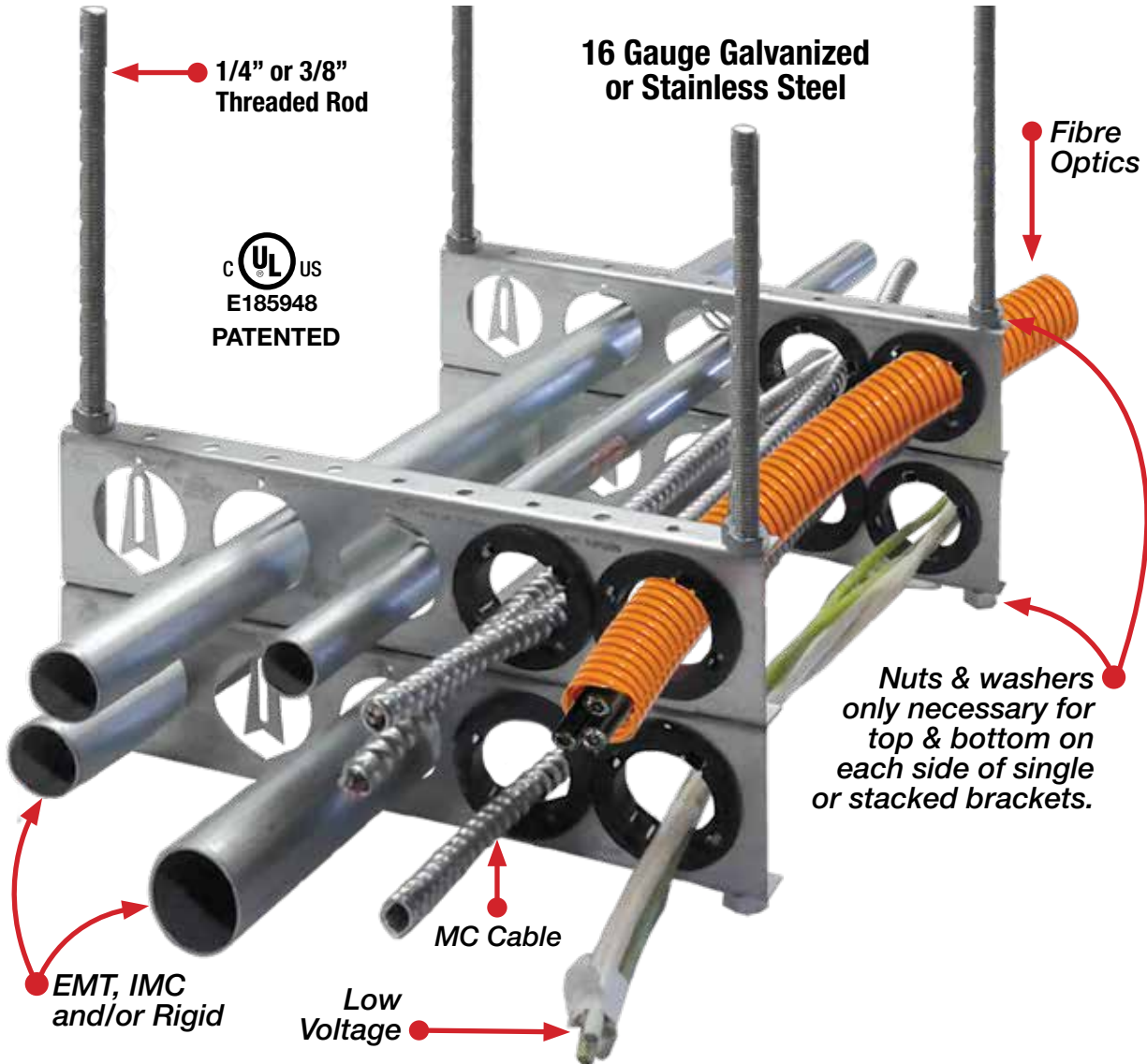

Customer must satisfy all codes and owners' specifications.



PATENT PENDING
PATENTED



LABELS APPLY TO PRODUCTS ONLY WHERE SHOWN ABOVE

730 Pratt Boulevard • Elk Grove Village, IL 60007
P: (847) 593-8595 • F: (847) 593-8629 • Toll-free (800) 233-8595
E: info@spproducts.com • www.spproducts.com

IP11a

Custom Trapeze Brackets



Lay-In...

Available in Any Gauge Galvanized or Stainless Steel and Any Size Conduit or Configuration. Consult Factory.

Example: for 4" EMT Li
EZUTB 4-4, and EMT Li

PATENTED

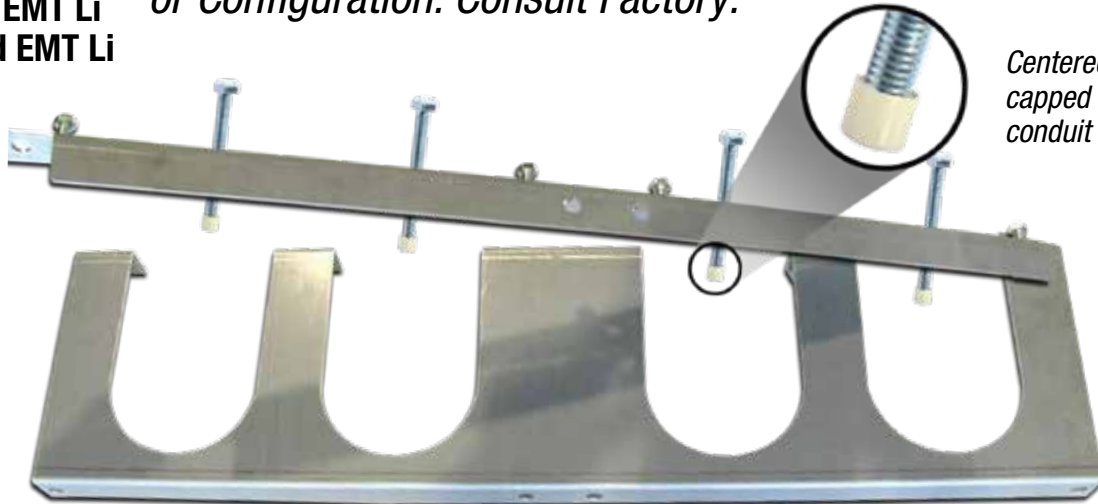

Centered captive capped bolts hold conduit in place

or Feed Thru

Example: 4 - Four Inch Conduits
EZUTB 4-4 EMT

PATENT PENDING



For Larger Size Conduits Eliminate ALL Conduit Clamps

Customer must satisfy all codes and owners' specifications.



PATENT PENDING
PATENTED



LABELS APPLY TO PRODUCTS ONLY WHERE SHOWN ABOVE

730 Pratt Boulevard • Elk Grove Village, IL 60007
P: (847) 593-8595 • F: (847) 593-8629 • Toll-free (800) 233-8595
E: info@spproducts.com • www.spproducts.com

IP11b

Wide Bottom Flange



Allows Drill Chuck Clearance When Installing Vertically on Walls or Horizontally on Decks.

Cat#	4-Way Desc.	Wt. Ea.	Qty/Box
EZUTB(Length)-WF	16 Gauge Galvanized or Stainless Steel (SS)	0.7 lbs.	25



1-3/4" taller version for conduit clearance from deck.
Consult factory for price and availability.

Custom Trapeze Bracket Eliminate ALL Conduit Clamps



Tell Us What You Need... We'll Make It!
Available in Any Gauge Galvanized or Stainless Steel and Any Size Conduit or Configurations
Contact Factory

Customer must satisfy all codes and owners' specifications.



PATENT PENDING
PATENTED



LABELS APPLY TO PRODUCTS ONLY WHERE SHOWN ABOVE

730 Pratt Boulevard • Elk Grove Village, IL 60007
P: (847) 593-8595 • F: (847) 593-8629 • Toll-free (800) 233-8595
E: info@spproducts.com • www.spproducts.com

IP11c



Transition Slip Couplings



PVC CONDUIT SCH 40 & 80 NO REAMING BITS NEEDED!



PATENTED



IP12a
PVC to Rigid

IP12b
PVC to Flexible

IP12c
PVC to Liquidtight

IP12d
PVC to Aluminum

IP12e
PVC to EMT

IP12f
PVC to Stainless Steel

IP12g
PVC to End Bell

IP12h
PVC to Smooth Bushing

Transition Slip Couplings are ideal for all types of projects plus save a great deal of money:

- Waste Water Treatment Plants
- Food Processing Plants
- Data Centers
- Hospitals
- Stadiums
- Expo Centers
- Light Rail
- Military Facilities
- Airports
- Museums

Step 1 - Install PVC Coupling prior to pour and cap (Conduit Plug IP27c) or tape

Step 2 - Glue Slip Coupling into PVC Coupling

Step 3 - Install PVC Conduit into PVC Slip Coupling

Use On Entire Job Not Just For Repair!

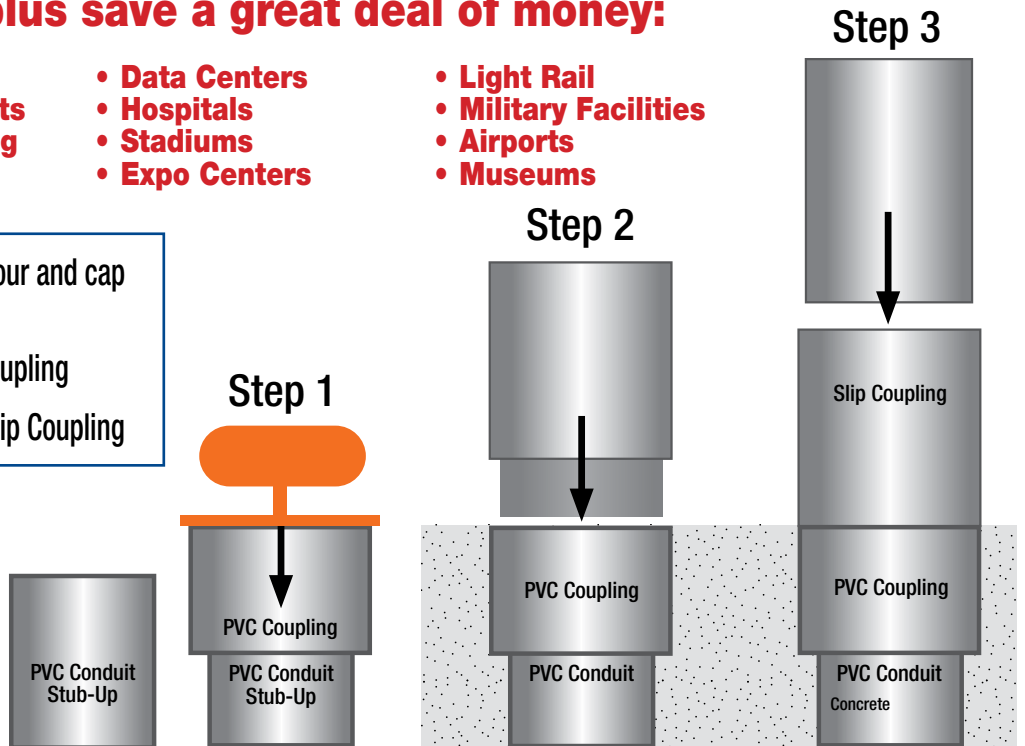

Customer must satisfy all codes and owners' specifications.



PATENT PENDING
PATENTED

LABELS APPLY TO PRODUCTS ONLY WHERE SHOWN ABOVE



730 Pratt Boulevard • Elk Grove Village, IL 60007
 P: (847) 593-8595 • F: (847) 593-8629 • Toll-free (800) 233-8595
 E: info@spproducts.com • www.spproducts.com

IP12

Transition Couplings



PVC Schedule 40 & 80 Slip to Galvanized Rigid

Save at Least
1 Hour per
Installation.



Transitions in One Minute

**Save Cost on the Rigid
Nipple, Tape & Labor**

**Use for Entire Job -
Not Just for Repair**

**Reamer NOT Required to
Transition from PVC to Rigid**

**Apply PVC Cement
to Secure &
Complete**



See Our
Conduit Plug
See page IP27c

1/2" thru 6"

Transition Couplings	
Size	Catalog #
1/2"	50 SLIP/RGD
3/4"	75 SLIP/RGD
1"	100 SLIP/RGD
1-1/4"	125 SLIP/RGD
1-1/2"	150 SLIP/RGD
2"	200 SLIP/RGD
2-1/2"	250 SLIP/RGD
3"	300 SLIP/RGD
3-1/2"	350 SLIP/RGD
4"	400 SLIP/RGD
5"	500 SLIP/RGD
6"	600 SLIP/RGD

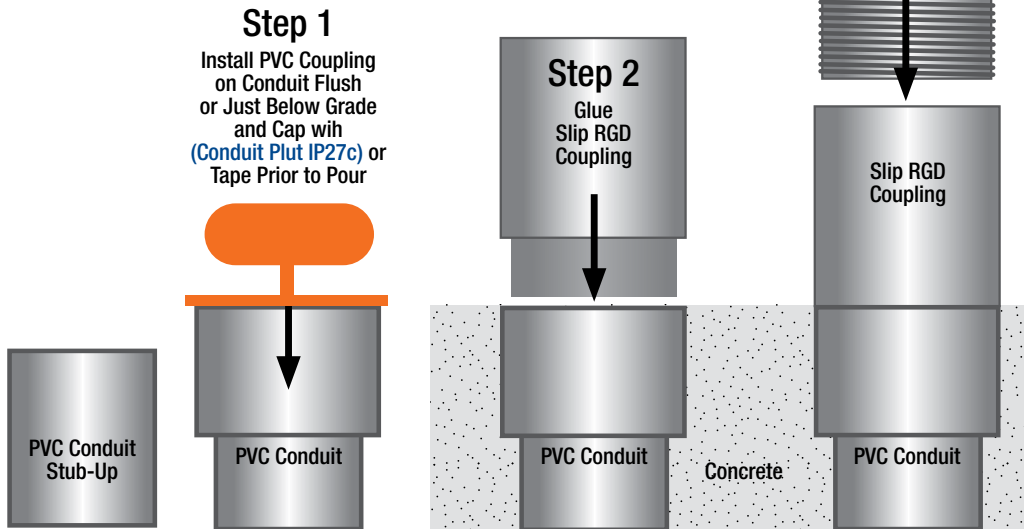

All SP Products Inc. Transition Fittings are manufactured for installation to either meet or exceed in accordance with NEMA TC2, TC3 or UL 651 specifications

Customer must satisfy all codes and owners' specifications.



PATENT PENDING
PATENTED



LABELS APPLY TO PRODUCTS ONLY WHERE SHOWN ABOVE

730 Pratt Boulevard • Elk Grove Village, IL 60007
P: (847) 593-8595 • F: (847) 593-8629 • Toll-free (800) 233-8595
E: info@spproducts.com • www.spproducts.com

IP12a

Transition Couplings



PVC Schedule 40 & 80

Slip to Flexible



Transitions in One Minute

Save Cost on the Rigid Nipple, Tape & Labor

Use for Entire Job - Not Just for Repair

Reamer NOT Required to Transition from PVC to Flexible Conduit

Apply PVC Cement to Secure & Complete



Step 1
Install PVC Coupling on Conduit Flush or Just Below Grade and Cap with (Conduit Plug IP27c) or Tape Prior to Pour

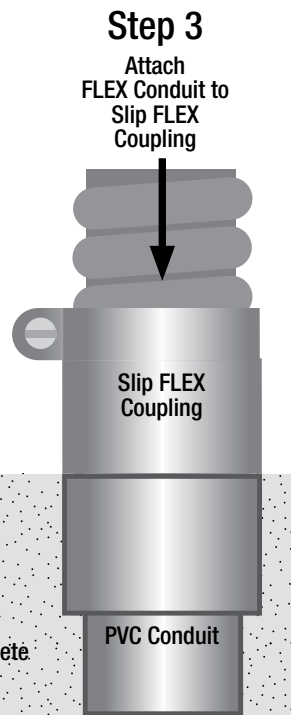
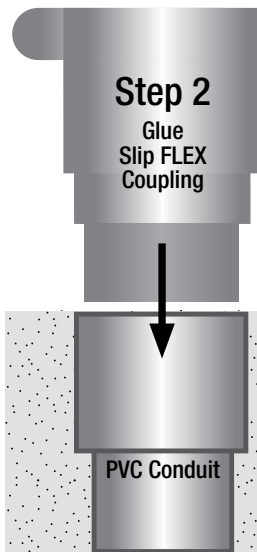
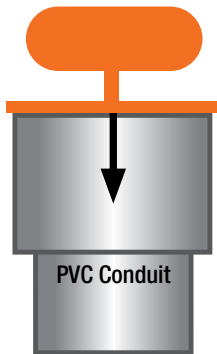

1/2" thru 1-1/2"

Transition Couplings	
Size	Catalog #
1/2"	50 SLIP/FLEX
3/4"	75 SLIP/FLEX
1"	100 SLIP/FLEX
1-1/4"	125 SLIP/FLEX
1-1/2"	150 SLIP/FLEX

All SP Products Inc. Transition Fittings are manufactured for installation to either meet or exceed in accordance with NEMA TC2, TC3 or UL 651 specifications

Customer must satisfy all codes and owners' specifications.



PATENT PENDING
PATENTED



LABELS APPLY TO PRODUCTS ONLY WHERE SHOWN ABOVE

730 Pratt Boulevard • Elk Grove Village, IL 60007
P: (847) 593-8595 • F: (847) 593-8629 • Toll-free (800) 233-8595
E: info@spproducts.com • www.spproducts.com

IP12b

Transition Couplings



PVC Schedule 40 & 80 Slip to Liquidtite

Save at Least
1 Hour per
Installation.



Transitions in One Minute

Save Cost on the Rigid Nipple, Tape & Labor

Use for Entire Job - Not Just for Repair

**Reamer NOT Required to Transition
from PVC to Liquidtite**

**Apply PVC Cement
to Secure &
Complete**



Step 3
Attach
Liquidtite Conduit to
Slip Liquidtite
Coupling

1/2" thru 4"

Transition Couplings	
Size	Catalog #
1/2"	50 SLIP/LIQ
3/4"	75 SLIP/LIQ
1"	100 SLIP/LIQ
1-1/4"	125 SLIP/LIQ
1-1/2"	150 SLIP/LIQ
2"	200 SLIP/LIQ
2-1/2"	250 SLIP/LIQ
3"	300 SLIP/LIQ
3-1/2"	350 SLIP/LIQ
4"	400 SLIP/LIQ

Step 1
Install PVC Coupling
on Conduit Flush
or Just Below Grade
and Cap with
(Conduit Plug IP27c) or
Tape Prior to Pour

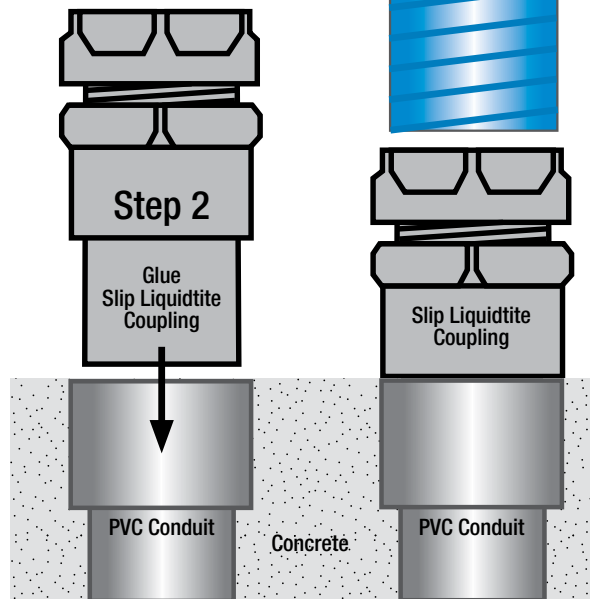
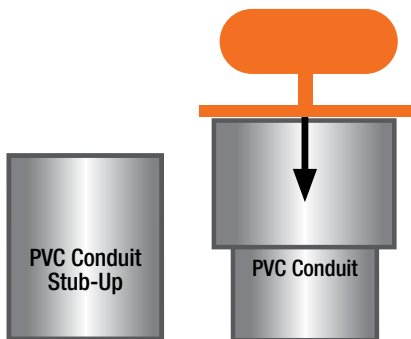

All SP Products Inc. Transition Fittings are manufactured for installation to either meet or exceed in accordance with NEMA TC2, TC3 or UL 651 specifications

Customer must satisfy all codes and owners' specifications.



PATENT PENDING
PATENTED

LABELS APPLY TO PRODUCTS ONLY WHERE SHOWN ABOVE



730 Pratt Boulevard • Elk Grove Village, IL 60007
P: (847) 593-8595 • F: (847) 593-8629 • Toll-free (800) 233-8595
E: info@spproducts.com • www.spproducts.com

IP12c

Transition Couplings



PVC Schedule 40 & 80 Slip to Aluminum

Save at Least
1 Hour per
Installation.



PATENTED



Transitions in One Minute

Save Cost on the Rigid Nipple, Tape & Labor

Use for Entire Job - Not Just for Repair

**Reamer NOT Required to Transition
from PVC to Aluminum Conduit**

**Apply PVC Cement
to Secure & Complete**



See Our
Conduit Plug
See page IP27c

All SP Products Inc. Transition Fittings are manufactured for installation to either meet or exceed in accordance with NEMA TC2, TC3 or UL 651 specifications

1/2" thru 6"

Transition Couplings

Size	Catalog #
1/2"	50 SLIP/ALUM
3/4"	75 SLIP/ALUM
1"	100 SLIP/ALUM
1-1/4"	125 SLIP/ALUM
1-1/2"	150 SLIP/ALUM
2"	200 SLIP/ALUM
2-1/2"	250 SLIP/ALUM
3"	300 SLIP/ALUM
3-1/2"	350 SLIP/ALUM
4"	400 SLIP/ALUM
5"	500 SLIP/ALUM
6"	600 SLIP/ALUM

Step 1
Install PVC Coupling
on Conduit Flush
or Just Below Grade
and Cap with
(Conduit Plug IP27c) or
Tape Prior to Pour

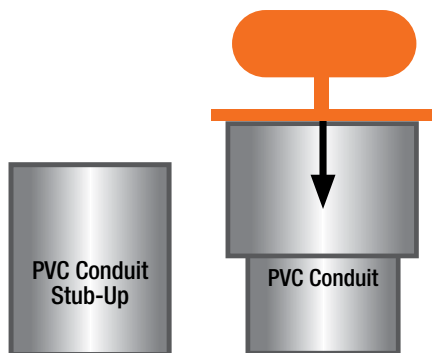

Step 2
Glue
Slip Aluminum
Coupling

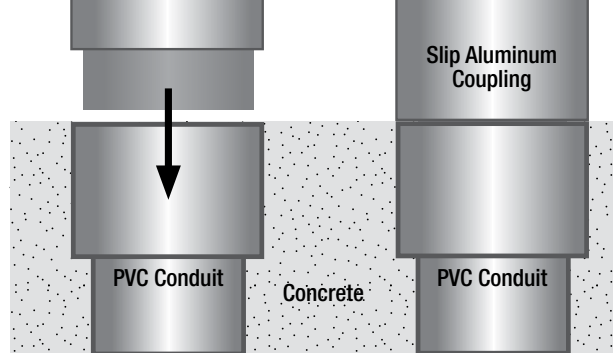

Step 3
Attach
Aluminum Conduit
to Slip Aluminum
Coupling



Customer must satisfy all codes and owners' specifications.

SP PRODUCTS, INC
Productivity and value thru ideas



PATENT PENDING
PATENTED



LABELS APPLY TO PRODUCTS ONLY WHERE SHOWN ABOVE

730 Pratt Boulevard • Elk Grove Village, IL 60007
P: (847) 593-8595 • F: (847) 593-8629 • Toll-free (800) 233-8595
E: info@spproducts.com • www.spproducts.com

IP12d

Transition Couplings



PVC Schedule 40 & 80 Slip to EMT

Save at Least
1 Hour per
Installation.



PATENTED



Transitions in One Minute

Save Cost on the Rigid Nipple, Tape & Labor

Use for Entire Job - Not Just for Repair

**Reamer NOT Required to Transition
from PVC to EMT Conduit**

**Apply PVC Cement
to Secure & Complete**



1/2" thru 4"

Step 1
Install PVC Coupling
on Conduit Flush
or Just Below Grade
and Cap with
(Conduit Plug IP27c) or
Tape Prior to Pour

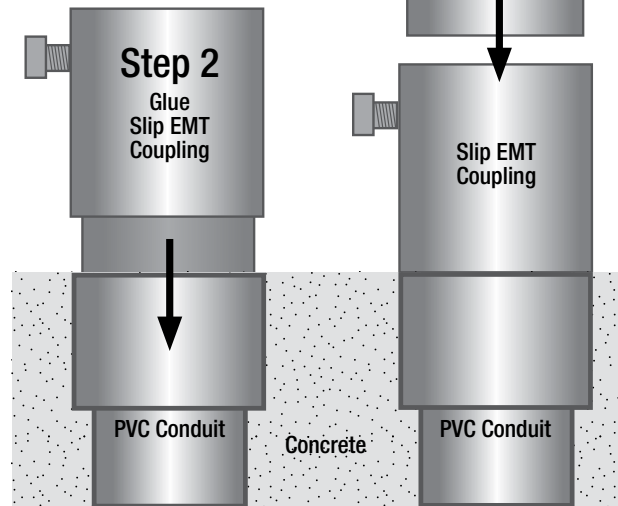
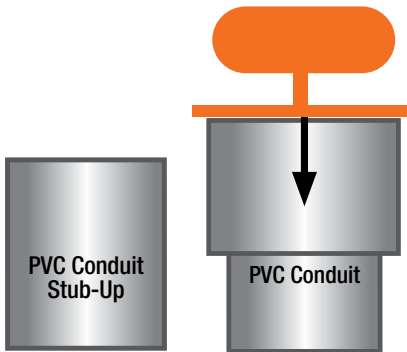

Transition Couplings	
Size	Catalog #
1/2"	50 SLIP/EMT
3/4"	75 SLIP/EMT
1"	100 SLIP/EMT
1-1/4"	125 SLIP/EMT
1-1/2"	150 SLIP/EMT
2"	200 SLIP/EMT
2-1/2"	250 SLIP/EMT
3"	300 SLIP/EMT
3-1/2"	350 SLIP/EMT
4"	400 SLIP/EMT

All SP Products Inc. Transition Fittings are manufactured for installation to either meet or exceed in accordance with NEMA TC2, TC3 or UL 651 specifications

Customer must satisfy all codes and owners' specifications.



PATENT PENDING
PATENTED



LABELS APPLY TO PRODUCTS ONLY WHERE SHOWN ABOVE

730 Pratt Boulevard • Elk Grove Village, IL 60007
P: (847) 593-8595 • F: (847) 593-8629 • Toll-free (800) 233-8595
E: info@spproducts.com • www.spproducts.com

IP12e

Transition Couplings



PVC Schedule 40 & 80 Slip to Stainless Steel



PATENTED



Transitions in One Minute

**Save Cost on the Rigid Nipple,
Tape & Labor**

**Use for Entire Job -
Not Just for Repair**

**Reamer NOT Required to Transition
from PVC to Stainless Steel Conduit**

**Apply PVC Cement
to Secure & Complete**



Step 1
Install PVC Coupling
on Conduit Flush
or Just Below Grade
and Cap with
(Conduit Plug IP27c) or
Tape Prior to Pour

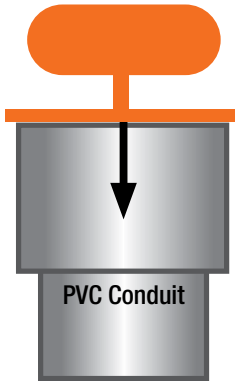

Step 2
Glue
Slip Stainless Steel
Coupling

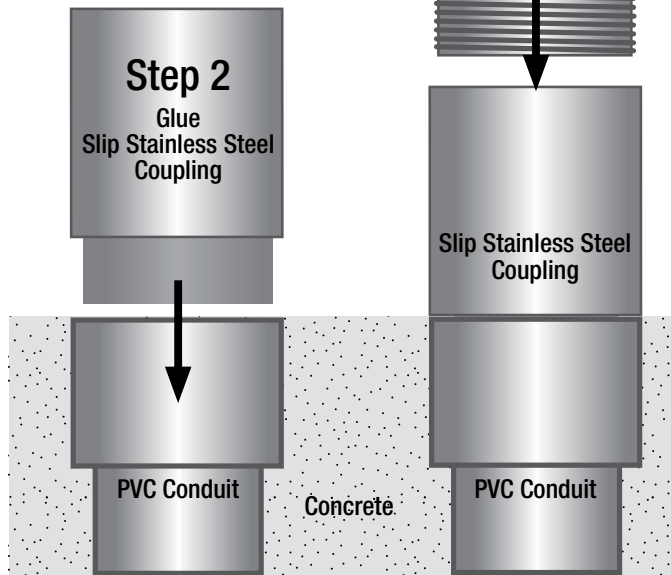

Step 3

Attach
Stainless Steel
Conduit to Slip
Stainless Steel
Coupling



1/2" thru 4"

Transition Couplings	
Size	Catalog #
1/2"	50 SLIP/SS
3/4"	75 SLIP/SS
1"	100 SLIP/SS
1-1/4"	125 SLIP/SS
1-1/2"	150 SLIP/SS
2"	200 SLIP/SS
2-1/2"	250 SLIP/SS
3"	300 SLIP/SS
3-1/2"	350 SLIP/SS
4"	400 SLIP/SS

All SP Products Inc. Transition Fittings are manufactured for installation to either meet or exceed in accordance with NEMA TC2, TC3 or UL 651 specifications

Customer must satisfy all codes and owners' specifications.



PATENT PENDING
PATENTED



LABELS APPLY TO PRODUCTS ONLY WHERE SHOWN ABOVE

730 Pratt Boulevard • Elk Grove Village, IL 60007
P: (847) 593-8595 • F: (847) 593-8629 • Toll-free (800) 233-8595
E: info@spproducts.com • www.spproducts.com

IP12f

Transition Couplings



PVC Schedule 40 & 80 Slip to End Bell



Transitions in One Minute
Save Cost on the Rigid Nipple, Tape & Labor

Use for Entire Job - Not Just for Repair

**Reamer NOT Required to Transition
from PVC to End Bell**

**Apply PVC Cement to
Secure & Complete**



cUL^{us}
PATENTED

1/2" thru 6"

Transition Couplings

Size	Catalog #
1/2"	50 SLIP/EB
3/4"	75 SLIP/EB
1"	100 SLIP/EB
1-1/4"	125 SLIP/EB
1-1/2"	150 SLIP/EB
2"	200 SLIP/EB
2-1/2"	250 SLIP/EB
3"	300 SLIP/EB
3-1/2"	350 SLIP/EB
4"	400 SLIP/EB
5"	500 SLIP/EB
6"	600 SLIP/EB

All SP Products Inc. Transition Fittings are manufactured for installation to either meet or exceed in accordance with NEMA TC2, TC3 or UL 651 specifications

Step 1
Install PVC Coupling on Conduit Flush or Just Below Grade and Cap with (Conduit Plug IP27c) or Tape Prior to Pour

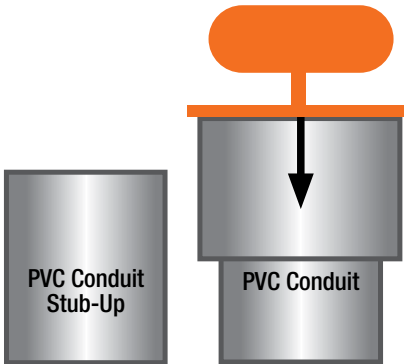

Step 2
Glue Slip End Bell Coupling

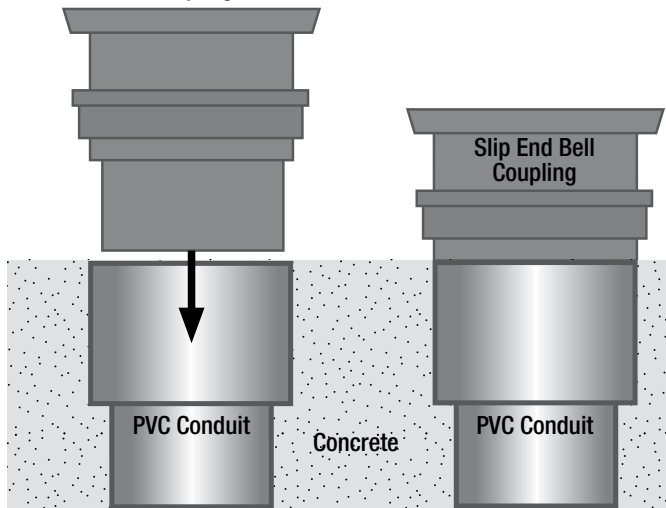

Customer must satisfy all codes and owners' specifications.

SP PRODUCTS, INC
Productivity and value thru ideas



PATENT PENDING
PATENTED



LABELS APPLY TO PRODUCTS ONLY WHERE SHOWN ABOVE

730 Pratt Boulevard • Elk Grove Village, IL 60007
P: (847) 593-8595 • F: (847) 593-8629 • Toll-free (800) 233-8595
E: info@spproducts.com • www.spproducts.com

IP12g

Transition Couplings



PVC Schedule 40 & 80 Slip to Smooth Bushing

Save at Least
1 Hour per
Installation.

PATENTED

Transitions in One Minute

Save Cost on the Rigid Nipple, Tape & Labor

Use for Entire Job - Not Just for Repair

Reamer NOT Required to Transition from PVC to Smooth Bushing (SB)

Apply PVC Cement to Secure & Complete



1/2" thru 4"

Transition Couplings

Size	Catalog #
1/2"	50 SLIP/SB
3/4"	75 SLIP/SB
1"	100 SLIP/SB
1-1/4"	125 SLIP/SB
1-1/2"	150 SLIP/SB
2"	200 SLIP/SB
2-1/2"	250 SLIP/SB
3"	300 SLIP/SB
3-1/2"	350 SLIP/SB
4"	400 SLIP/SB

Step 1
Install PVC Coupling on Conduit Flush or Just Below Grade and Cap with (Conduit Plug IP27c) or Tape Prior to Pour

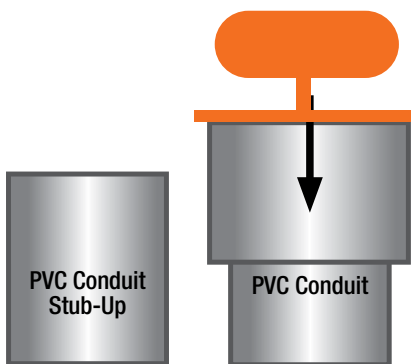

Step 2
Glue Slip SB Coupling

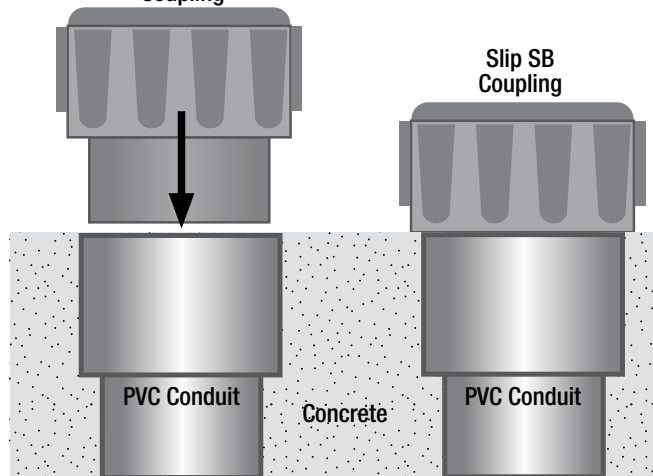

All SP Products Inc. Transition Fittings are manufactured for installation to either meet or exceed in accordance with NEMA TC2, TC3 or UL 651 specifications

Customer must satisfy all codes and owners' specifications.

SP PRODUCTS, INC
Productivity and value thru ideas



PATENT PENDING
PATENTED



LABELS APPLY TO PRODUCTS ONLY WHERE SHOWN ABOVE

730 Pratt Boulevard • Elk Grove Village, IL 60007
P: (847) 593-8595 • F: (847) 593-8629 • Toll-free (800) 233-8595
E: info@spproducts.com • www.spproducts.com

IP12h



PATENTED

Transition Fittings

PVC CONDUIT SCH 40 & 80 When Exiting out of the Slab



All SP Products Inc. Transition Fittings are manufactured for installation to either meet or exceed in accordance with NEMA TC2, TC3 or UL 651 specifications.



IP13a

PVC to PVC



IP13b

PVC to EMT



IP13c

PVC to Rigid



IP13d

PVC to Flex



IP13e

PVC to EMT Comp.



IP13f

PVC to Liquidtite



IP13g

PVC to Aluminum



IP13h

PVC to Stainless Steel

END BELL PVC CONDUIT SCH 40 & 80

NO REEMING BITS REQUIRED



IP13i

PVC to Galvanized Rigid



PVC End Bell to GRC

NEW

IP13r



PVC End Bell to EMT

NEW

IP13s



PVC End Bell to Liquidtite

NEW

IP13t



PVC End Bell to Flex

NEW

IP13u



IP13j

PVC to Bushing Adapter

See conduit sizing charts on pages IP13a thru IP13q



IP3k

PVC to PVC Inside to Inside



IP3l

PVC to Threaded PVC



IP3m

Male PVC Threaded to PVC



IP3n

Female PVC Threaded to PVC



IP3p

3/4" PVC to MC Cable



IP3q

PVC to PVC Reducers

Customer must satisfy all codes and owners' specifications.



Productivity and value thru ideas



PATENT PENDING
PATENTED

LABELS APPLY TO PRODUCTS ONLY WHERE SHOWN ABOVE



730 Pratt Boulevard • Elk Grove Village, IL 60007
P: (847) 593-8595 • F: (847) 593-8629 • Toll-free (800) 233-8595
E: info@spproducts.com • www.spproducts.com

IP13



PATENTED

Transition Fittings

PVC CONDUIT SCH 40 & 80 When Exiting out of the Slab



Transition couplings for all types of projects that save a great deal of money:

- Data Centers**
- Food Processing Plants**
- Stadiums**
- Military Facilities**
- Waste Water Treatment Plants**
- Hospitals**
- Expo Centers**
- Airports**
- Light Rail**
- Museums**



Use On Entire Job – Not Just For Repair!



Sizes From 1/2" thru 6"



PATENT PENDING
PATENTED



LABELS APPLY TO PRODUCTS ONLY WHERE SHOWN ABOVE

730 Pratt Boulevard • Elk Grove Village, IL 60007
P: (847) 593-8595 • F: (847) 593-8629 • Toll-free (800) 233-8595
E: info@spproducts.com • www.spproducts.com

IP13¹

Transition Couplings



PVC Schedule 40 & 80 to PVC Conduit

Save
at Least
1 Hour per
Installation.



**Prevents Damage
to PVC Risers**

**Use for Entire Job -
Not Just for Repair**



1/2" thru 6"

Transition Couplings UL Listed up thru 6"	
Size	Catalog #
1/2"	50PVC/PVC
3/4"	75PVC/PVC
1"	100PVC/PVC
1-1/4"	125PVC/PVC
1-1/2"	150PVC/PVC
2"	200PVC/PVC
2-1/2"	250PVC/PVC
3"	300PVC/PVC
3-1/2"	350PVC/PVC
4"	400PVC/PVC
5"	500PVC/PVC
6"	600PVC/PVC

All SP Products Inc. Transition Fittings are manufactured for installation to either meet or exceed in accordance with NEMA TC2, TC3 or UL 651 specifications

All Above Meet UL651
CSA C22.2, No.85 and
US Army Corps Engineers
Specifications

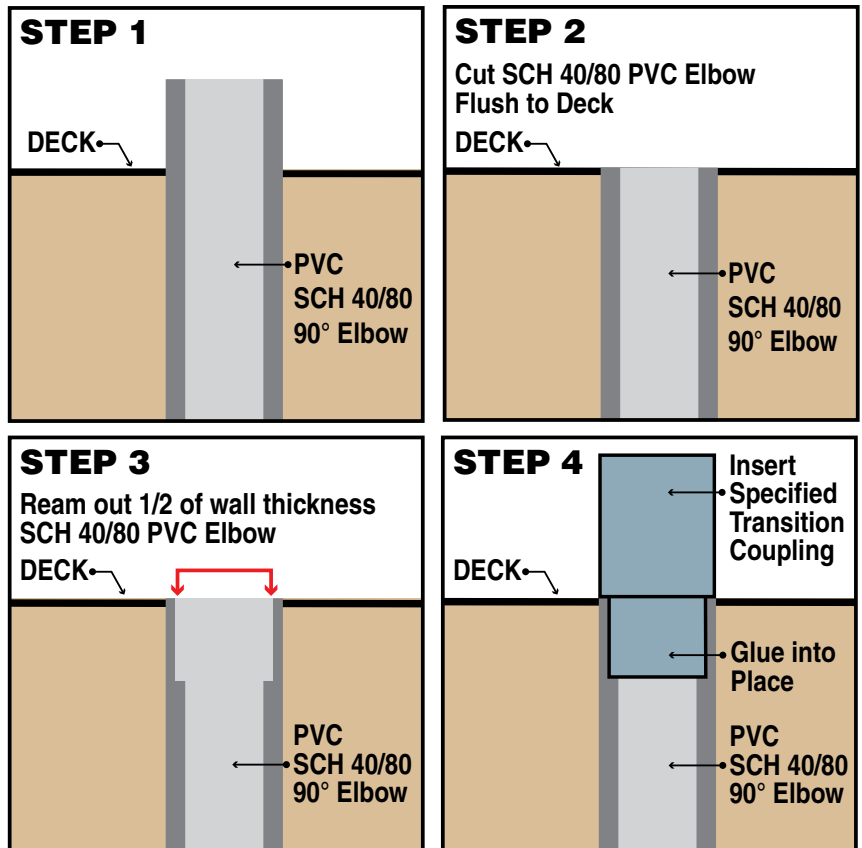

Customer must satisfy all codes and owners' specifications.



PATENT PENDING
PATENTED



LABELS APPLY TO PRODUCTS ONLY WHERE SHOWN ABOVE

730 Pratt Boulevard • Elk Grove Village, IL 60007
P: (847) 593-8595 • F: (847) 593-8629 • Toll-free (800) 233-8595
E: info@spproducts.com • www.spproducts.com

IP13a

Transition Couplings



PVC Schedule 40 & 80 to EMT Conduit



Save at Least
1 Hour per
Installation.

**Transitions in
Less Than 5 Minutes!**

**Save Cost on the Rigid
Nipple, Tape & Labor**

**Use for Entire Job -
Not Just for Repair**



1/2" thru 4"

All SP Products Inc. Transition Fittings are manufactured for installation to either meet or exceed in accordance with NEMA TC2, TC3 or UL 651 specifications

Transition Couplings	
Size	Catalog #
1/2"	50PVC/EMT
3/4"	75PVC/EMT
1"	100PVC/EMT
1-1/4"	125PVC/EMT
1-1/2"	150PVC/EMT
2"	200PVC/EMT
2-1/4"	250-PVC/EMT
3"	300PVC/EMT
3-1/2"	350PVC/EMT
4"	400PVC/EMT

For any size conduit and configuration either galvanized or stainless steel. Consult Factory

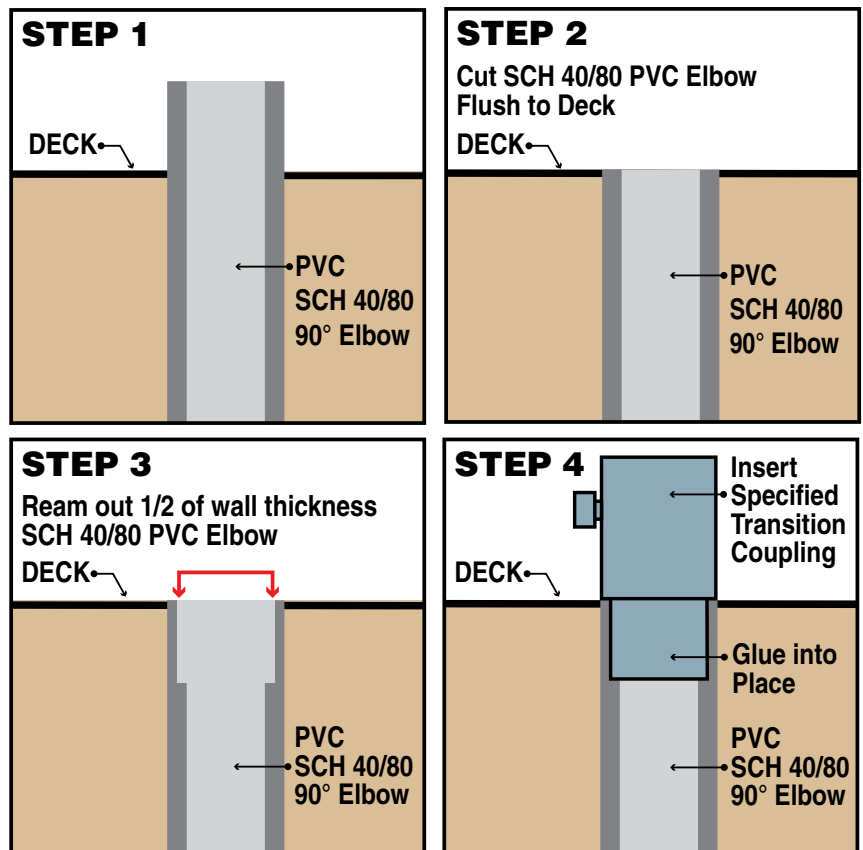

Customer must satisfy all codes and owners' specifications.



PATENT PENDING
PATENTED



LABELS APPLY TO PRODUCTS ONLY WHERE SHOWN ABOVE

730 Pratt Boulevard • Elk Grove Village, IL 60007
P: (847) 593-8595 • F: (847) 593-8629 • Toll-free (800) 233-8595
E: info@spproducts.com • www.spproducts.com

IP13b

Transition Couplings



PVC Schedule 40 & 80 to Rigid Conduit

Save
at Least
1 Hour per
Installation.

Transitions in
Less Than 5 Minutes!

Save Cost on the Rigid
Nipple, Tape & Labor

Use for Entire Job -
Not Just for Repair



1/2" thru 6"

Transition Couplings	
Size	Catalog #
1/2"	50PVC/RGD
3/4"	75PVC/RGD
1"	100PVC/RGD
1-1/4"	125PVC/RGD
1-1/2"	150PVC/RGD
2"	200PVC/RGD
2-1/2"	250PVC/RGD
3"	300PVC/RGD
3-1/2"	350PVC/RGD
4"	400PVC/RGD
5"	500PVC/RGD
6"	600PVC/RGD

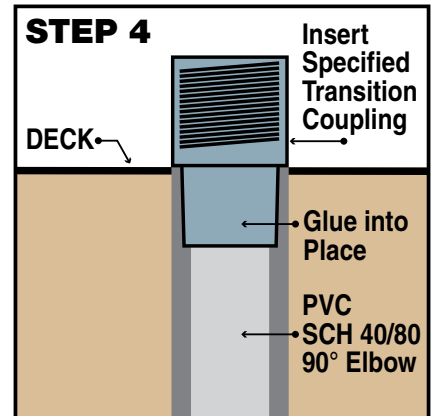
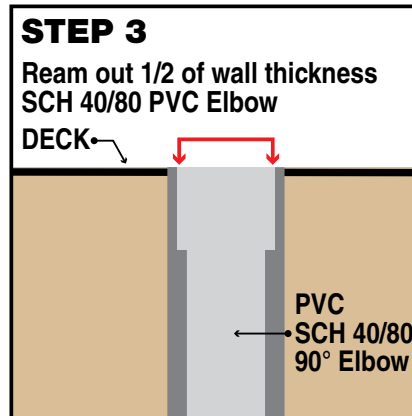
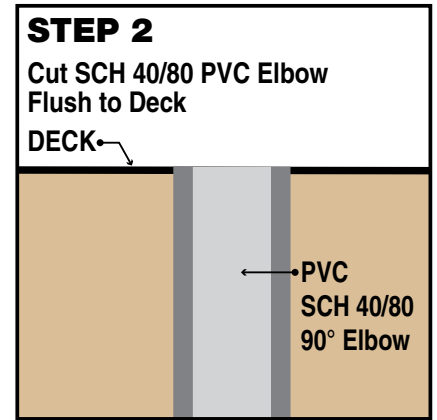
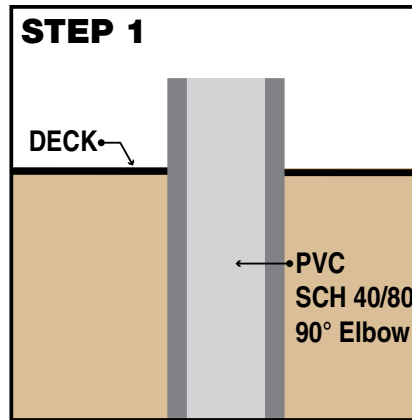

All SP Products Inc. Transition Fittings are manufactured for installation to either meet or exceed in accordance with NEMA TC2, TC3 or UL 651 specifications

Customer must satisfy all codes and owners' specifications.



PATENT PENDING
PATENTED



LABELS APPLY TO PRODUCTS ONLY WHERE SHOWN ABOVE

730 Pratt Boulevard • Elk Grove Village, IL 60007
P: (847) 593-8595 • F: (847) 593-8629 • Toll-free (800) 233-8595
E: info@spproducts.com • www.spproducts.com

IP13c

Transition Couplings



PVC Schedule 40 & 80 to Flexible Metal Conduit

Save
at Least
1 Hour per
Installation.



PATENTED



**Transitions in
Less Than 5 Minutes!**

**Save Cost on the Rigid
Nipple, Tape & Labor**

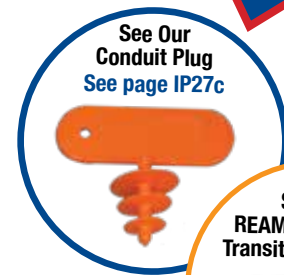
**Use for Entire Job -
Not Just for Repair**



All SP Products Inc.
Transition Fittings are manufactured for
installation to either meet or exceed
in accordance with NEMA TC2, TC3 or
UL 651 specifications

1/2" thru 1-1/2"

Transition Couplings	
Size	Catalog #
1/2"	50PVC/FLEX
3/4"	75PVC/FLEX
1"	100PVC/FLEX
1-1/4"	125PVC/FLEX
1-1/2"	150PVC/FLEX

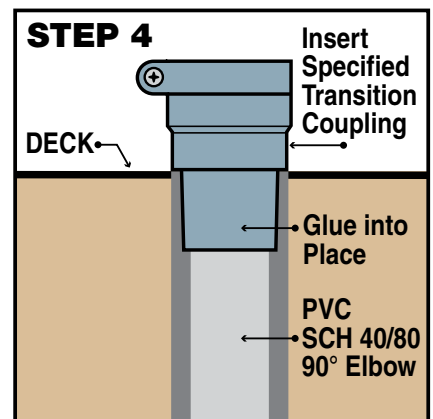
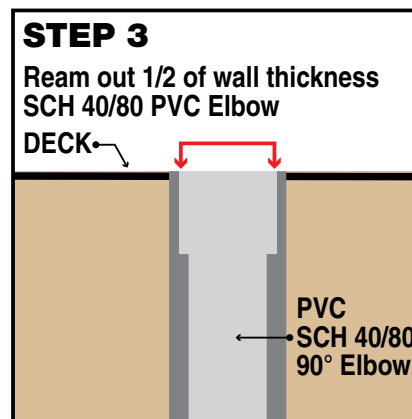
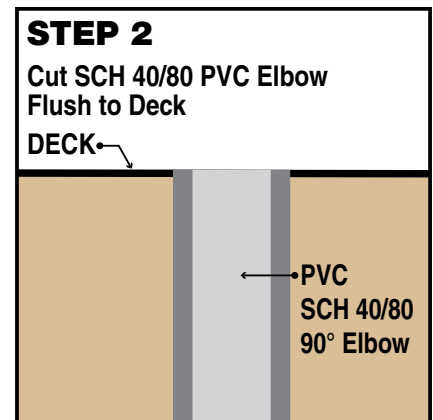
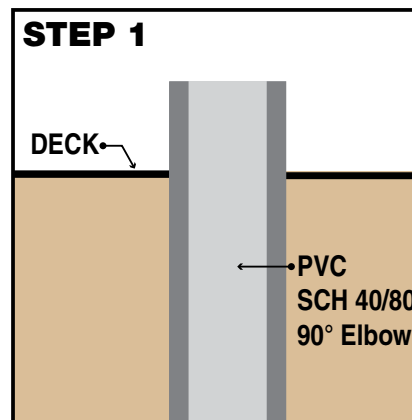

Customer must satisfy all codes and owners' specifications.

SP PRODUCTS, INC
Productivity and value thru ideas



PATENT PENDING
PATENTED



LABELS APPLY TO PRODUCTS ONLY WHERE SHOWN ABOVE

730 Pratt Boulevard • Elk Grove Village, IL 60007
P: (847) 593-8595 • F: (847) 593-8629 • Toll-free (800) 233-8595
E: info@spproducts.com • www.spproducts.com

IP13d

Transition Couplings



PVC Schedule 40 & 80 to EMT Compression

PATENTED



Save at Least
1 Hour per
Installation.

Transitions in
Less Than 5 Minutes!

Save Cost on the Rigid
Nipple, Tape & Labor

Use for Entire Job -
Not Just for Repair



All SP Products Inc. Transition Fittings are manufactured for installation to either meet or exceed in accordance with NEMA TC2, TC3 or UL 651 specifications

1/2" thru 4"

Transition Couplings	
Size	Catalog #
1/2"	50PVC/EMT-C
3/4"	75PVC/EMT-C
1"	100PVC/EMT-C
1-1/4"	125PVC/EMT-C
1-1/2"	150PVC/EMT-C
2"	200PVC/EMT-C
2-1/2"	250PVC/EMT-C
3"	300PVC/EMT-C
4"	400PVC/EMT-C

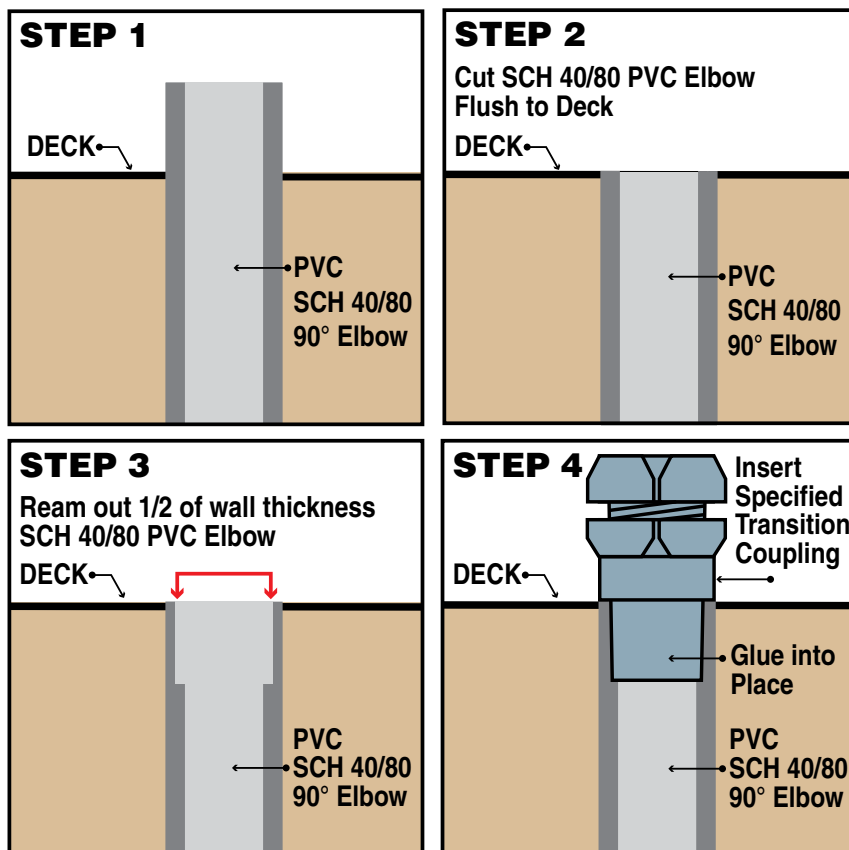

Customer must satisfy all codes and owners' specifications.



PATENT PENDING
PATENTED



LABELS APPLY TO PRODUCTS ONLY WHERE SHOWN ABOVE

730 Pratt Boulevard • Elk Grove Village, IL 60007
P: (847) 593-8595 • F: (847) 593-8629 • Toll-free (800) 233-8595
E: info@spproducts.com • www.spproducts.com

IP13e

Transition Couplings



PVC Schedule 40 & 80 to Sealtite/Liquidtite

Save
at Least
1 Hour per
Installation.



**Transitions in
Less Than 5 Minutes!**

**Save Cost on the Rigid
Nipple, Tape & Labor**

**Use for Entire Job -
Not Just for Repair**

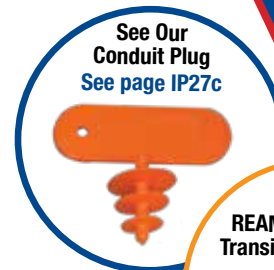

PATENTED

1/2" thru 4"

Transition Couplings

Size	Catalog #
1/2"	50-PVC/LIQ
3/4"	75PVC/LIQ
1"	100PVC/LIQ
1-1/4"	125PVC/LIQ
1-1/2"	150PVC/LIQ
2"	200PVC/LIQ
2-1/2"	250PVC/LIQ
3"	300PVC/LIQ
3-1/2"	350PVC/LIQ
4"	400PVC/LIQ

All SP Products Inc. Transition Fittings are manufactured for installation to either meet or exceed in accordance with NEMA TC2, TC3 or UL 651 specifications

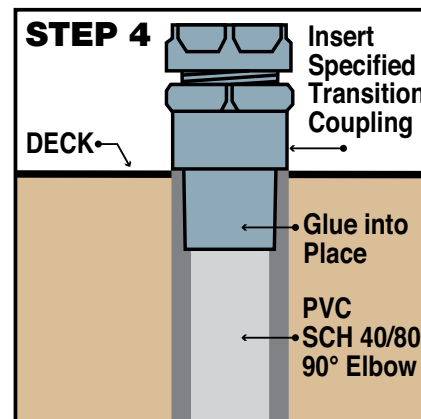
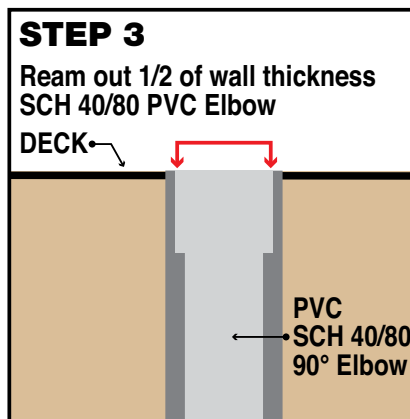
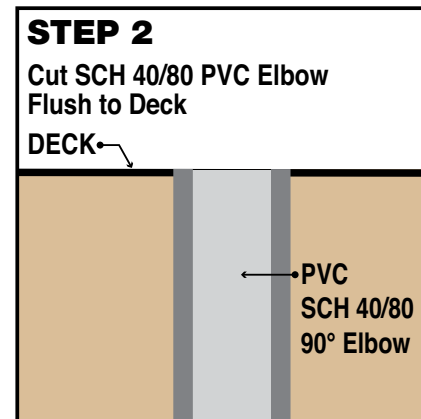
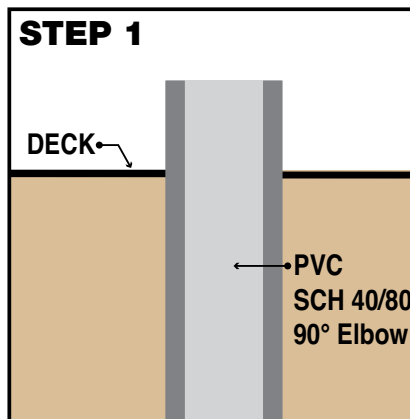

Customer must satisfy all codes and owners' specifications.



PATENT PENDING
PATENTED



LABELS APPLY TO PRODUCTS ONLY WHERE SHOWN ABOVE

730 Pratt Boulevard • Elk Grove Village, IL 60007

P: (847) 593-8595 • F: (847) 593-8629 • Toll-free (800) 233-8595

E: info@spproducts.com • www.spproducts.com

IP13f

Transition Couplings



PVC Schedule 40 & 80 to Aluminum Conduit

Save
at Least
1 Hour per
Installation.



PATENTED



**Transitions in
Less Than 5 Minutes!**

**Save Cost on the Rigid
Nipple, Tape & Labor**

**Use for Entire Job -
Not Just for Repair**



1/2" thru 6"

Transition Couplings	
Size	Catalog #
1/2"	50PVC/ALUM
3/4"	75PVC/ALUM
1"	100PVC/ALUM
1-1/4"	125PVC/ALUM
1 1/2"	150PVC/ALUM
2"	200PVC/ALUM
2-1/2"	250PVC/ALUM
3"	300PVC/ALUM
3-1/2"	350PVC/ALUM
4"	400PVC/ALUM
5"	500PVC/ALUM
6"	600PVC/ALUM

All SP Products Inc. Transition Fittings are manufactured for installation to either meet or exceed in accordance with NEMA TC2, TC3 or UL 651 specifications

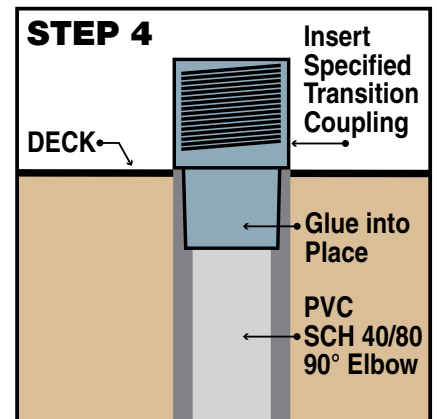
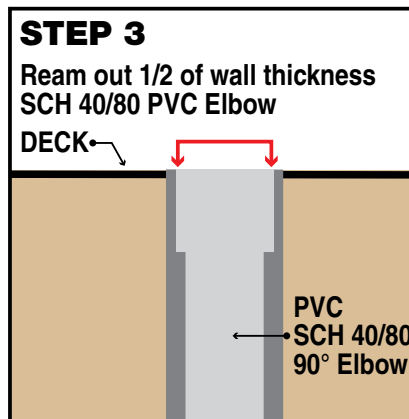
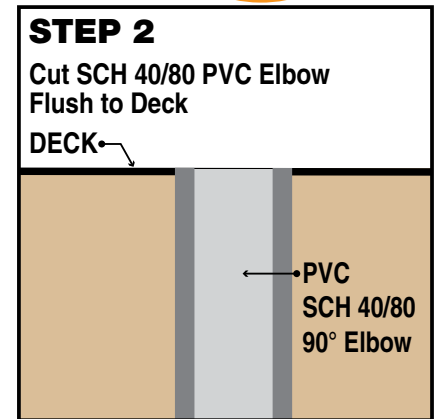
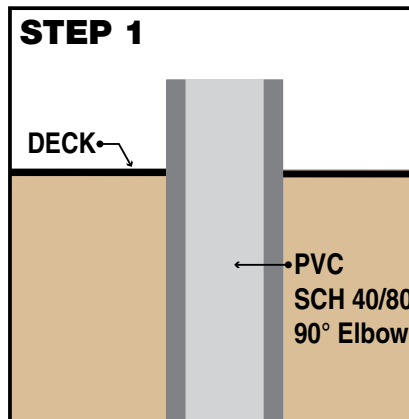

Customer must satisfy all codes and owners' specifications.



PATENT PENDING
PATENTED



LABELS APPLY TO PRODUCTS ONLY WHERE SHOWN ABOVE

730 Pratt Boulevard • Elk Grove Village, IL 60007
P: (847) 593-8595 • F: (847) 593-8629 • Toll-free (800) 233-8595
E: info@spproducts.com • www.spproducts.com

IP13g

Transition Fittings

PVC Schedule 40 & 80 to Stainless Steel Conduit



Save
at Least
1 Hour per
Installation.



PATENTED



**Transitions in
Less Than 5 Minutes!**

**Save Cost on the Rigid
Nipple, Tape & Labor**

**Use for Entire Job -
Not Just for Repair**

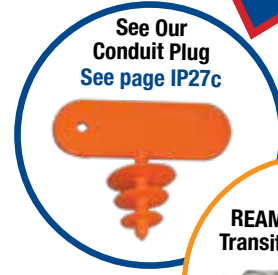

1/2" thru 4"

Transition Couplings	
Size	Catalog #
1/2"	50PVC/SS
3/4"	75PVC/SS
1"	100PVC/SS
1-1/4"	125PVC/SS
1-1/2"	150PVC/SS
2"	200PVC/SS
2-1/2"	250PVC/SS
3"	300PVC/SS
3-1/2"	350PVC/SS
4"	400PVC/SS

All SP Products Inc. Transition Fittings are manufactured for installation to either meet or exceed in accordance with NEMA TC2, TC3 or UL 651 specifications

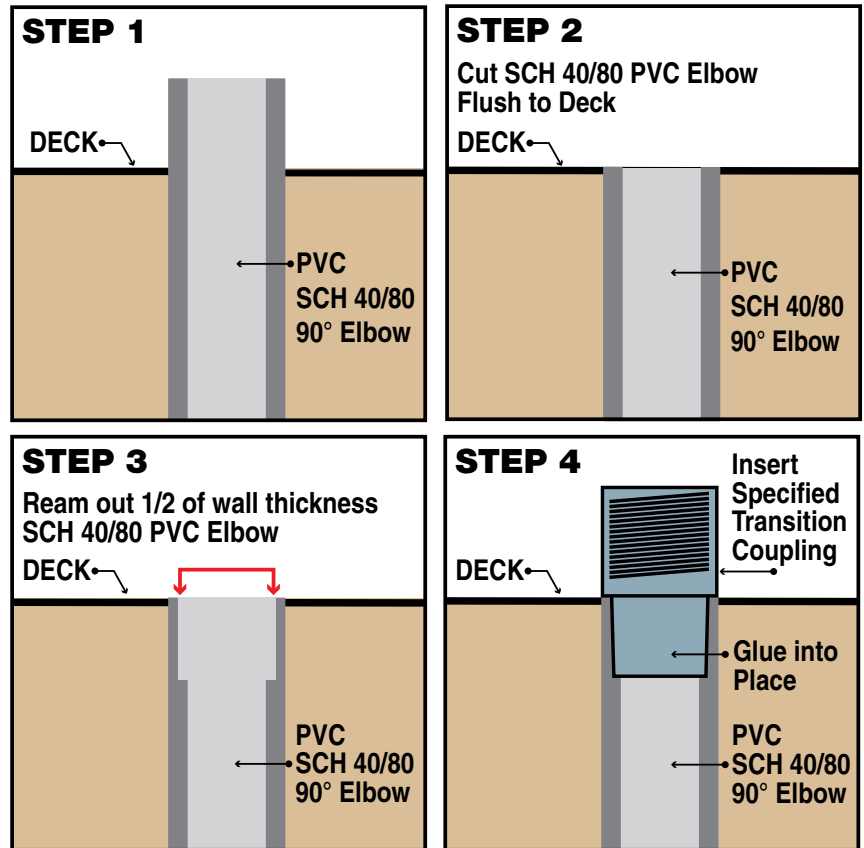

Customer must satisfy all codes and owners' specifications.



PATENT PENDING
PATENTED



LABELS APPLY TO PRODUCTS ONLY WHERE SHOWN ABOVE

730 Pratt Boulevard • Elk Grove Village, IL 60007
P: (847) 593-8595 • F: (847) 593-8629 • Toll-free (800) 233-8595
E: info@spproducts.com • www.spproducts.com

IP13h

Transition Couplings



PVC Schedule 40 & 80 End Bell to Galvanized Rigid Conduit



Quickly Transition Galvanized Rigid or Rigid Nipple Conduit to Pvc End Bell

Save at Least **1 Hour** per Installation.



QQYZ & QQYZ7
E80659

PATENT PENDING

1/2" thru 6"

Transition Couplings	
Size	Catalog #
1/2"	50-GRC-EB
3/4"	75-GRC-EB
1"	100-GRC-EB
1-1/4"	125-GRC-EB
1 1/2"	150-GRC-EB
2"	200-GRC-EB
2-1/2"	250-GRC-EB
3"	300-GRC-EB
3-1/2"	350-GRC-EB
4"	400-GRC-EB
5"	500-GRC-EB
6"	600-GRC-EB

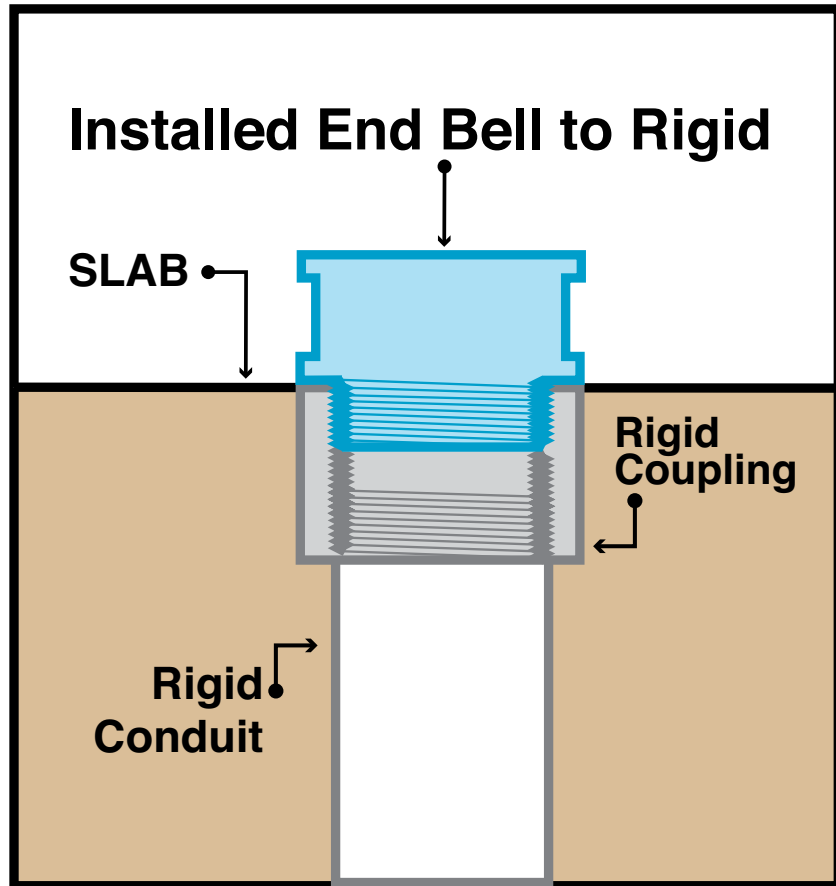

Customer must satisfy all codes and owners' specifications.



PATENT PENDING
PATENTED



LABELS APPLY TO PRODUCTS ONLY WHERE SHOWN ABOVE

730 Pratt Boulevard • Elk Grove Village, IL 60007
P: (847) 593-8595 • F: (847) 593-8629 • Toll-free (800) 233-8595
E: info@spproducts.com • www.spproducts.com

IP13i

Transition Bushing Adapter



SCH 40 PVC to Smooth Bushing

Smooth edge allows trouble free wire pulls



Transition Bushing Adapter for Pulling Wire

3 Holes on 120° centers to receive tapped lugs

Install one with every connector

Ideal for installing transformers & switchgear



Transition Bushing Adapter for Pulling Grounding Wire

SIZE	CAT#
1/2"	50PVC/SB
3/4"	75PVC/SB
1"	100PVC/SB
1-1/4"	125PVC/SB
1-1/2"	150PVC/SB
2"	200PVC/SB
2-1/2"	250PVC/SB
3"	300PVC/SB
3-1/2"	350PVC/SB
4"	400PVC/SB

SIZE	CAT#
1/2"	50PVC/GSB
3/4"	75PVC/GSB
1"	100PVC/GSB
1-1/4"	125PVC/GSB
1-1/2"	150PVC/GSB
2"	200PVC/GSB
2-1/2"	250PVC/GSB
3"	300PVC/GSB
3-1/2"	350PVC/GSB
4"	400PVC/GSB

(Standard Slick Nut includes 1 Lug)

Must install 3 Lugs for UL Listing, extra lugs sold separately.

Consult Factory for prices and availability

Customer must satisfy all codes and owners' specifications.



PATENT PENDING
PATENTED



LABELS APPLY TO PRODUCTS ONLY WHERE SHOWN ABOVE

730 Pratt Boulevard • Elk Grove Village, IL 60007
 P: (847) 593-8595 • F: (847) 593-8629 • Toll-free (800) 233-8595
 E: info@spproducts.com • www.spproducts.com

IP13j

Transition Couplings



PVC Schedule 40 & 80 to Inside PVC to Inside PVC

Save at Least
1 Hour per Installation.

NEW



Saves a Great Deal of Time Repairing Conduit

The Inside Diameter Remains the Same

Allows for Trouble Free Wire and Cable Pulss



cUL US
PATENT PENDING

1/2" thru 6"

Transition Couplings	
Size	Catalog #
1/2"	50PVC-IN/PVC-IN
3/4"	75PVC-IN/PVC-IN
1"	100PVC-IN/PVC-IN
1-1/4"	125PVC-IN/PVC-IN
1 1/2"	150PVC-IN/PVC-IN
2"	200PVC-IN/PVC-IN
2-1/2"	250PVC-IN/PVC-IN
3"	300PVC-IN/PVC-IN
3-1/2"	350PVC-IN/PVC-IN
4"	400PVC-IN/PVC-IN
5"	500PVC-IN/PVC-IN
6"	600PVC-IN/PVC-IN

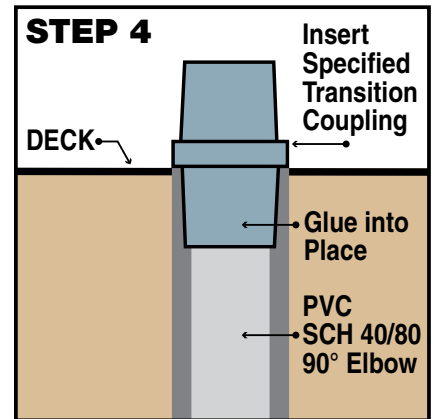
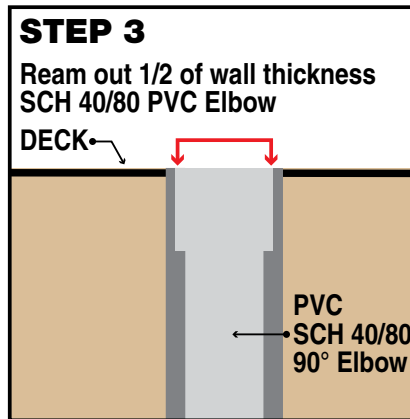
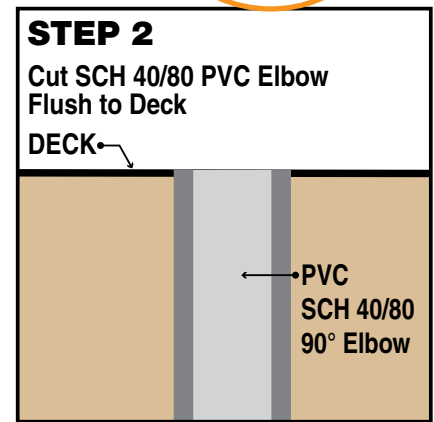
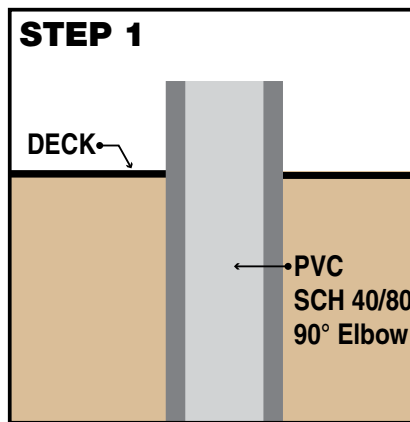

All SP Products Inc. Transition Fittings are manufactured for installation to either meet or exceed in accordance with NEMA TC2, TC3 or UL 651 specifications

Customer must satisfy all codes and owners' specifications.



PATENT PENDING
PATENTED



LABELS APPLY TO PRODUCTS ONLY WHERE SHOWN ABOVE

730 Pratt Boulevard • Elk Grove Village, IL 60007
P: (847) 593-8595 • F: (847) 593-8629 • Toll-free (800) 233-8595
E: info@spproducts.com • www.spproducts.com

IP13k

Transition Couplings



PVC Schedule 40 & 80 to PVC/PVC Threaded

Save at Least **1 Hour** per Installation.



Save a Great Deal of Time Repairing Conduit

The Inside Diameter Remains the Same

Allows for Trouble Free Wire and Cable Pulls

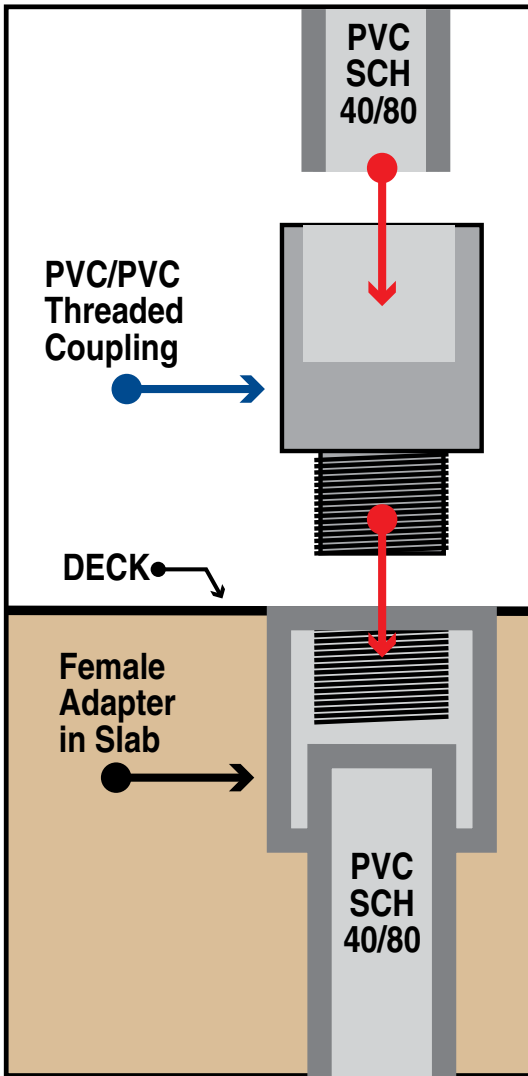

PATENT PENDING

1/2" thru 6"

Transition Couplings	
Size	Catalog #
1/2"	50-PVC/PVC-THR
3/4"	75-PVC/PVC-THR
1"	100-PVC/PVC-THR
1-1/4"	125-PVC/PVC-THR
1-1/2"	150-PVC/PVC-THR
2"	200-PVC/PVC-THR
2-1/2"	250-PVC/PVC-THR
3"	300-PVC/PVC-THR
3-1/2"	350-PVC/PVC-THR
4"	400-PVC/PVC-THR
5"	500-PVC/PVC-THR
6"	600-PVC/PVC-THR

All SP Products Inc. Transition Fittings are manufactured for installation to either meet or exceed in accordance with NEMA TC2, TC3 or UL 651 specifications

Customer must satisfy all codes and owners' specifications.



PATENT PENDING PATENTED



LABELS APPLY TO PRODUCTS ONLY WHERE SHOWN ABOVE

730 Pratt Boulevard • Elk Grove Village, IL 60007
 P: (847) 593-8595 • F: (847) 593-8629 • Toll-free (800) 233-8595
 E: info@spproducts.com • www.spproducts.com

IP131

Transition Couplings



PVC Schedule 40 & 80 to to Threaded PVC Conduit

Install on Concrete or
Masonry Walls

Support Box with Lock Nut

Supports Conduit
Runs in Any Direction

Eliminate Metal Box,
Hardware, Tape & Labor Cost

Save
at Least
1 Hour per
Installation.

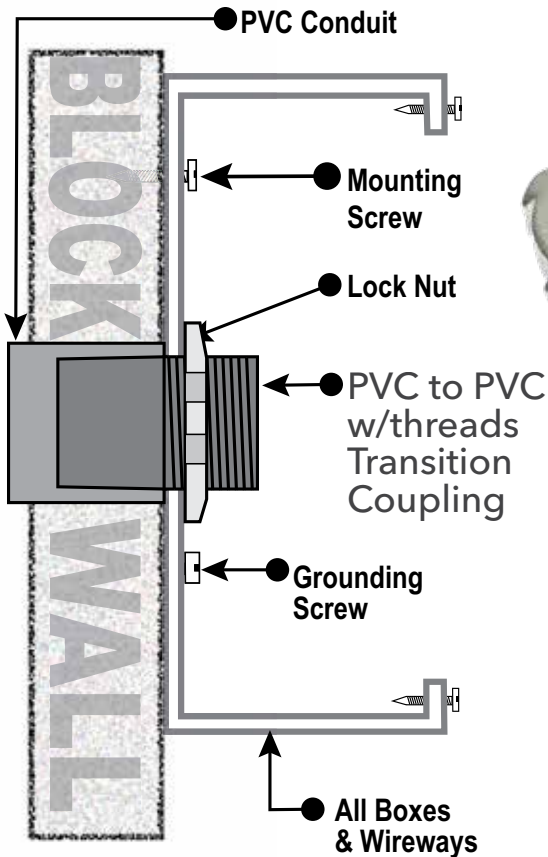
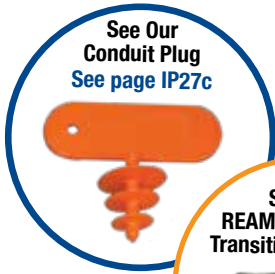

NEW

1/2" thru 6"

UL LISTED
PATENTED

All SP Products Inc.
Transition Fittings are manufactured for
installation to either meet or exceed
in accordance with NEMA TC2, TC3 or
UL 651 specifications

Transition Couplings
UL Listed up thru 1/2"

Size	Catalog #
1/2"	50-PVC/PVC-T
3/4"	75-PVC/PVC-T
1"	100-PVC/PVC-T
1-1/4"	125-PVC/PVC-T
1-1/2"	150-PVC/PVC-T
2"	200-PVC/PVC-T
2-1/2"	250-PVC/PVC-T
3"	300-PVC/PVC-T
3-1/2"	350-PVC/PVC-T
4"	400-PVC/PVC-T
5"	500-PVC/PVC-T
6"	600-PVC/PVC-T

Customer must satisfy all codes and owners' specifications.

SP PRODUCTS, INC
Productivity and value thru ideas



PATENT PENDING
PATENTED



LABELS APPLY TO PRODUCTS ONLY WHERE SHOWN ABOVE

730 Pratt Boulevard • Elk Grove Village, IL 60007
P: (847) 593-8595 • F: (847) 593-8629 • Toll-free (800) 233-8595
E: info@spproducts.com • www.spproducts.com

IP13m

PVC Tapered to Threaded Transition Couplings



to PVC Conduit Exiting Concrete Slab PVC Schedule 40 & 80

Save at Least
1 Hour per
Installation.



**Transitions in
Less Than 5 Minutes!**

**Save Cost on the Rigid
Nipple, Tape & Labor**

**Use for Entire Job -
Not Just for Repair**



UL US
LISTED
PATENT
PENDING

1/2" thru 6"

Transition Couplings	
Size	Catalog #
1/2"	50-PVC-T-THR
3/4"	75-PVC-T-THR
1"	100-PVC-T-THR
1-1/4"	125-PVC-T-THR
1-1/2"	150-PVC-T-THR
2"	200-PVC-T-THR
2-1/2"	250-PVC-T-THR
3"	300-PVC-T-THR
3-1/2"	350-PVC-T-THR
4"	400-PVC-T-THR
5"	450-PVC-T-THR
6"	500-PVC-T-THR

All Above Meet UL651
CSA C22.2, No.85 and
US Army Corps Engineers
Specifications

Saves a great deal of time transitioning from PVC conduit to MC Cable conduit above slab without damaging PVC risers and chipping concrete eliminating a concrete repair job!

All SP Products Inc. Transition Fittings are manufactured for installation to either meet or exceed in accordance with NEMA TC2, TC3 or UL 651 specifications

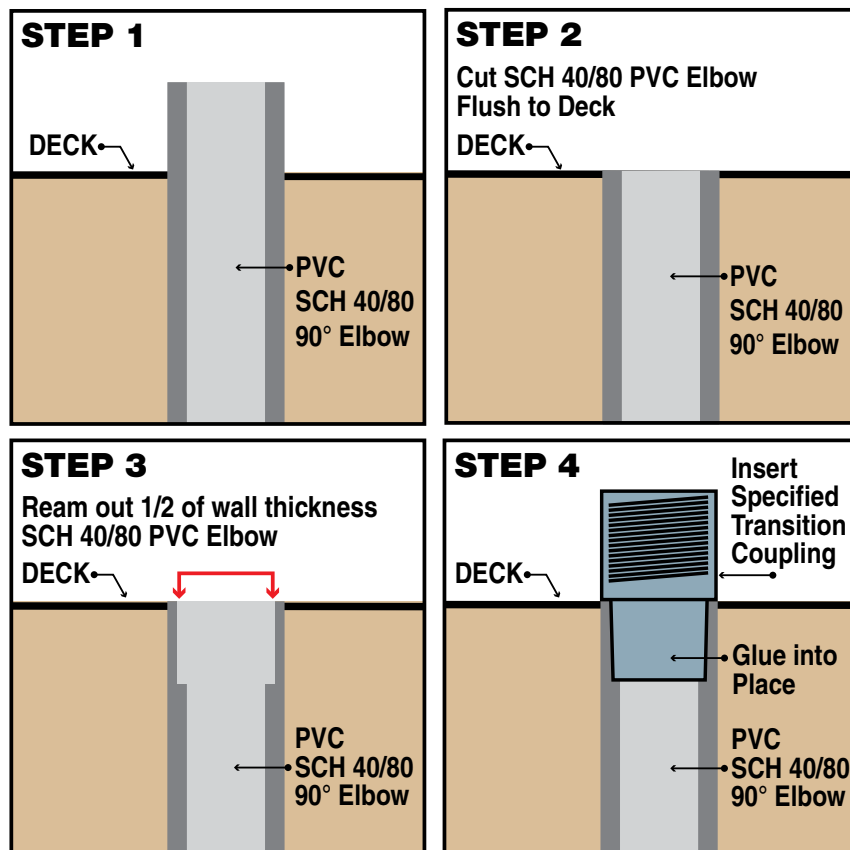

Customer must satisfy all codes and owners' specifications.



PATENT PENDING
PATENTED



LABELS APPLY TO PRODUCTS ONLY WHERE SHOWN ABOVE

730 Pratt Boulevard • Elk Grove Village, IL 60007
P: (847) 593-8595 • F: (847) 593-8629 • Toll-free (800) 233-8595
E: info@spproducts.com • www.spproducts.com

IP13n

NEW

Transition Couplings

3/4" PVC Schedule 40/80 to Greenfield or MC Cable



Save at Least **1 Hour** per Installation.

When Exiting Concrete Slab and Feeding to Load Centers.

Transitions in Less Than 5 Minutes!

Save Cost on the Rigid Nipple, Tape & Labor

Use for Entire Job - Not Just for Repair



Size	Cat#
3/4" x 1	75PVC-38/50 MC
3/4" x 2	75PVC-38/50 MC/DC

Saves a great deal of time transitioning from PVC conduit to Greenfield or MC Cable conduit above slab without damaging PVC risers and chipping concrete eliminating a concrete repair job!

All SP Products Inc. Transition Fittings are manufactured for installation to either meet or exceed in accordance with NEMA TC2, TC3 or UL 651 specifications

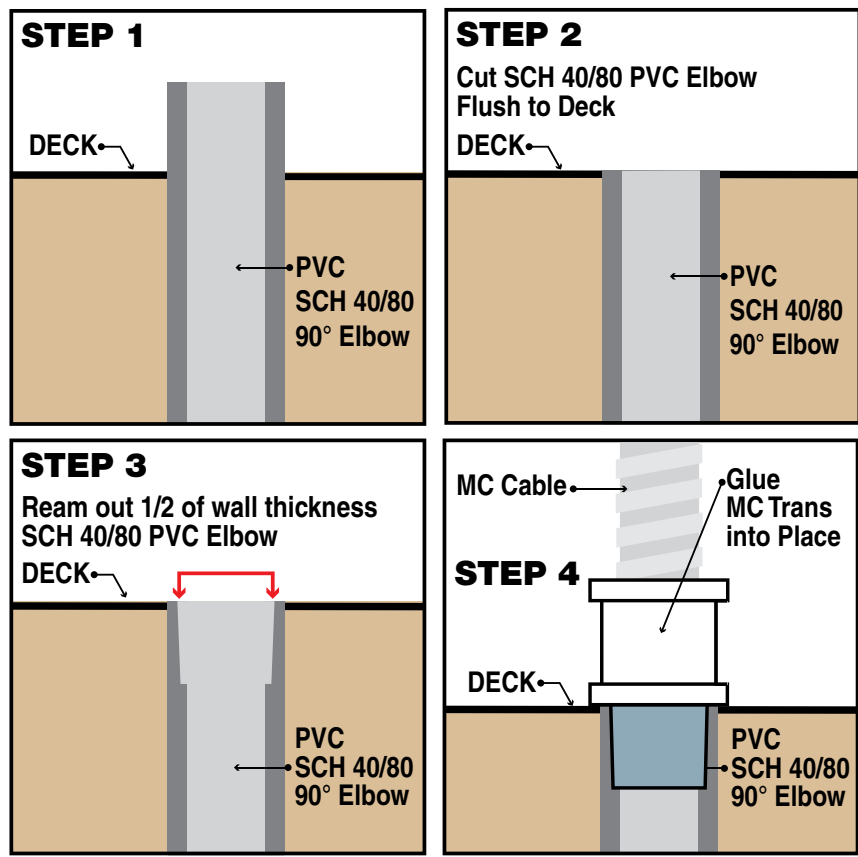

Customer must satisfy all codes and owners' specifications.



PATENT PENDING PATENTED



LABELS APPLY TO PRODUCTS ONLY WHERE SHOWN ABOVE

730 Pratt Boulevard • Elk Grove Village, IL 60007
 P: (847) 593-8595 • F: (847) 593-8629 • Toll-free (800) 233-8595
 E: info@spproducts.com • www.spproducts.com

IP13p

PVC REDUCERS

PVC SCH 40 & 80



Reduce any size PVC conduit to a smaller size PVC conduit

PVC Sch 40/80 Reducers from 3/4" to 6" any size combination available

Sample of Catalog Number:

75 PVC conduit through 600 PVC conduit - 100 PVC Reducer through 600 PVC Reducer or any size combinations in between.

Example: P/N 200PVC-125PVC Reducer Sch40 = 2" PVC to 1-1/4" PVC Reducer Sch40

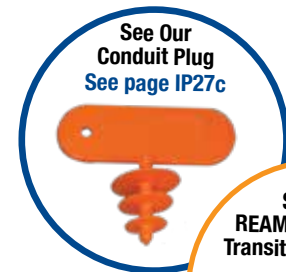

PATENT PENDING

See Our REAMING BITS for Transition Couplings



See page IP15



Customer must satisfy all codes and owners' specifications.



PATENT PENDING
PATENTED



LABELS APPLY TO PRODUCTS ONLY WHERE SHOWN ABOVE

730 Pratt Boulevard • Elk Grove Village, IL 60007
P: (847) 593-8595 • F: (847) 593-8629 • Toll-free (800) 233-8595
E: info@spproducts.com • www.spproducts.com

IP13q

Transition Couplings

PVC Bell End Adapter

Galvanized Rigid Conduit

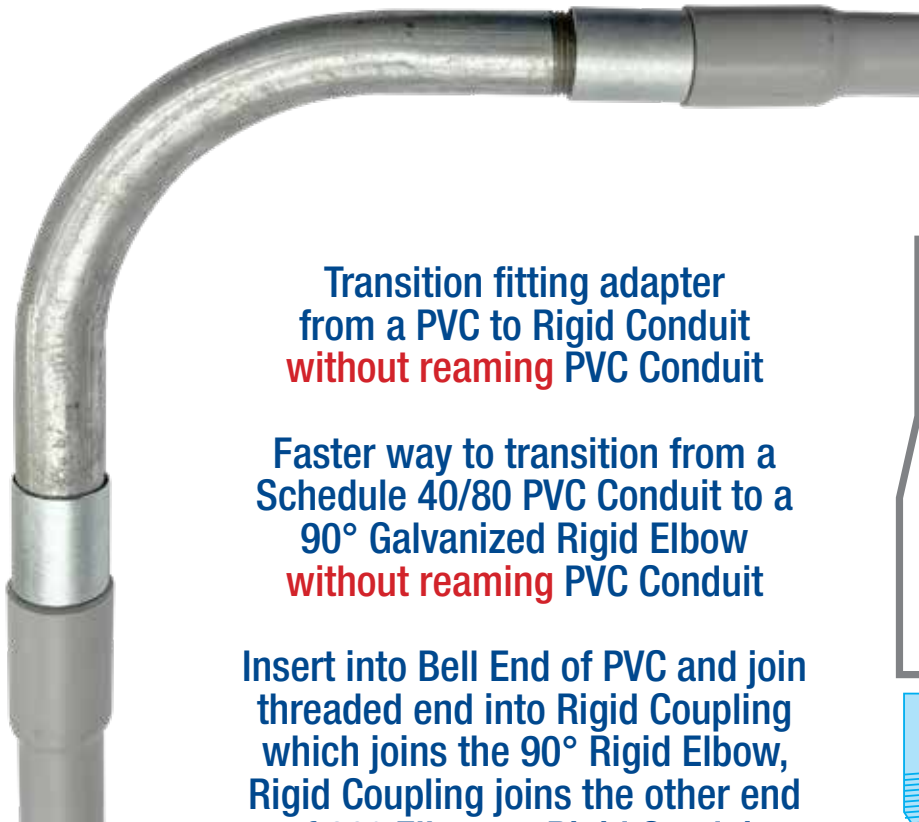

 US
 PATENT
 PENDING

Transition fitting adapter
from a PVC to Rigid Conduit
without reaming PVC Conduit

Faster way to transition from a
Schedule 40/80 PVC Conduit to a
90° Galvanized Rigid Elbow
without reaming PVC Conduit

Insert into Bell End of PVC and join
threaded end into Rigid Coupling
which joins the 90° Rigid Elbow,
Rigid Coupling joins the other end
of 90° Elbow to Rigid Conduit

Meets UL651 CSA CSS.L Ng83
and US Army Corps or
Engineers Specs.



1/2" thru 6"

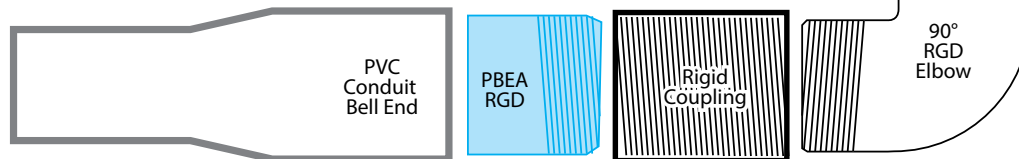
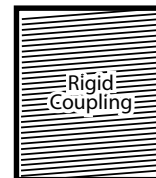

Transition Couplings	
Size	Catalog #
1/2"	PBEA/RGD 50
3/4"	PBEA/RGD 75
1"	PBEA/RGD 100
1-1/4"	PBEA/RGD 125
1 1/2"	PBEA/RGD 150
2"	PBEA/RGD 200
2-1/2"	PBEA/RGD 250
3"	PBEA/RGD 300
3-1/2"	PBEA/RGD 350
4"	PBEA/RGD 400
5"	PBEA/RGD 500
6"	PBEA/RGD 600

Customer must satisfy all codes and owners' specifications.

 **PRODUCTS, INC**
Productivity and value thru ideas



PATENT PENDING
PATENTED



LABELS APPLY TO PRODUCTS ONLY WHERE SHOWN ABOVE

730 Pratt Boulevard • Elk Grove Village, IL 60007
 P: (847) 593-8595 • F: (847) 593-8629 • Toll-free (800) 233-8595
 E: info@spproducts.com • www.spproducts.com

IP13r

Transition Couplings

PVC Bell End Adapter to EMT Conduit

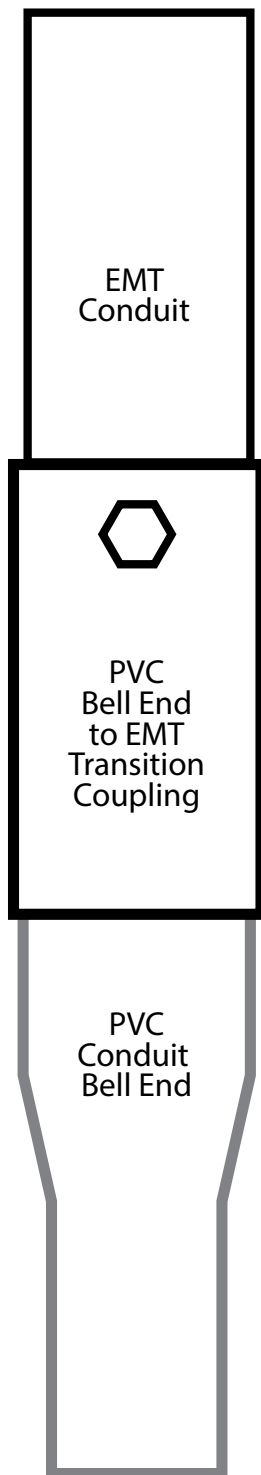

Transition fitting adapter from a PVC to EMT Conduit

Faster way to transition from a Schedule 40/80 PVC Conduit to EMT Conduit **without reaming** PVC Conduit

Insert into Bell End of PVC and Join with EMT Conduit by tightening bolt

Meets UL651 CSA CSS.L Ng83 and US Army Corps or Engineers Specs.



1/2" thru 4"

Transition Couplings		Transition Couplings	
Size	Catalog #	Size	Catalog #
1/2"	PBEA/EMT 50	2"	PBEA/EMT 200
3/4"	PBEA/EMT 75	2-1/2"	PBEA/EMT 250
1"	PBEA/EMT 100	3"	PBEA/EMT 300
1-1/4"	PBEA/EMT 125	3-1/2"	PBEA/EMT 350
1 1/2"	PBEA/EMT 150	4"	PBEA/EMT 400



PATENT PENDING

Customer must satisfy all codes and owners' specifications.



PATENT PENDING
PATENTED

LABELS APPLY TO PRODUCTS ONLY WHERE SHOWN ABOVE



730 Pratt Boulevard • Elk Grove Village, IL 60007
 P: (847) 593-8595 • F: (847) 593-8629 • Toll-free (800) 233-8595
 E: info@spproducts.com • www.spproducts.com

IP13s

Transition Couplings



PVC Bell End Adapter to Liquidtite Conduit

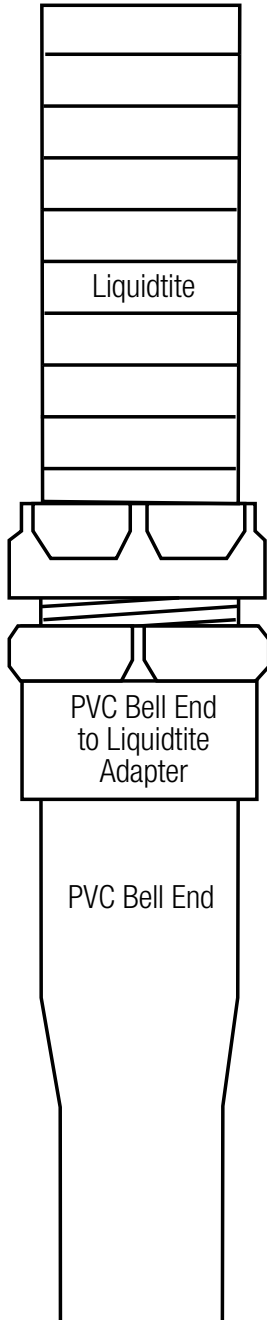

Transition fitting adapter
from a PVC to Liquidtite Conduit

Faster way to transition from a Schedule
40/80 PVC Conduit to Liquidtite Conduit
without reaming PVC Conduit

Insert into Bell End of PVC and Join
end into Liquidtite Conduit

Meets UL651 CSA CSS.L Ng83
and US Army Corps or Engineers Specs.



1/2" thru 4"

Transition Couplings	
Size	Catalog #
1/2"	PBEA/LIQ 50
3/4"	PBEA/LIQ 75
1"	PBEA/LIQ 100
1-1/4"	PBEA/LIQ 125
1 1/2"	PBEA/LIQ 150
2"	PBEA/LIQ 200
2-1/2"	PBEA/LIQ 250
3"	PBEA/LIQ 300
3-1/2"	PBEA/LIQ 350
4"	PBEA/LIQ 400



PATENTED

All SP Products Inc.
Transition Fittings are manufactured for
installation to either meet or exceed
in accordance with NEMA TC2, TC3 or
UL 651 specifications

Customer must satisfy all codes and owners' specifications.



PATENT PENDING
PATENTED



LABELS APPLY TO PRODUCTS ONLY WHERE SHOWN ABOVE

730 Pratt Boulevard • Elk Grove Village, IL 60007
P: (847) 593-8595 • F: (847) 593-8629 • Toll-free (800) 233-8595
E: info@spproducts.com • www.spproducts.com

IP13t

Transition Couplings



PVC Bell End Adapter to Flexible Conduit



Transition fitting adapter
from a PVC to Flexible Conduit

Faster way to transition from a Schedule
40/80 PVC Conduit to Flexible Conduit
without reaming PVC Conduit

Insert into Bell End of PVC and Join
end into Flexible Conduit

Meets UL651 CSA CSS.L Ng83
and US Army Corps or Engineers Specs.



PATENTED

1/2" thru 1-1/2"

Transition Couplings

Size	Catalog #
1/2"	PBEA/FLEX 50
3/4"	PBEA/FLEX 75
1"	PBEA/FLEX 100
1-1/2"	PBEA/FLEX 150

All SP Products Inc.

Transition Fittings are manufactured for
installation to either meet or exceed
in accordance with NEMA TC2, TC3 or
UL 651 specifications

Customer must satisfy all codes and owners' specifications.



PATENT PENDING
PATENTED

LABELS APPLY TO PRODUCTS ONLY WHERE SHOWN ABOVE



730 Pratt Boulevard • Elk Grove Village, IL 60007

P: (847) 593-8595 • F: (847) 593-8629 • Toll-free (800) 233-8595

E: info@spproducts.com • www.spproducts.com

IP13u

PVC End Bell Adapter PVC Schedule 40 & 80

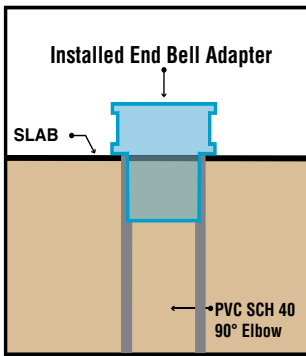

**Allows Faster Trouble Free Wire Pulls
Use for Entire Job - Not Just for Repair**

**Stub Up, Cut Flush to Slab, Ream Out PVC,
Glue in End Bell, Cap Conduit for a
Professional Looking Job!**



Sizes 1/2" thru 6"

Catalog #	Size
PEBA#50	1/2"
PEBA#75	3/4"
PEBA#100	1"
PEBA#125	1-1/4"
PEBA#150	1-1/2"
PEBA#200	2"
PEBA#250	2-1/2"
PEBA#300	3"
PEBA#350	3-1/2"
PEBA#400	4"
PEBA#500	5"
PEBA#600	6"



Qwikduct Templates can be used with all standardized trade size conduit specified per NPA 70 NEC



All Above Meet UL651
CSA C22.2, No.85 and
US Army Corps Engineers
Specifications

Perfect for use with QwikDuct HDPE Templates for Railway, Highway & Tollway

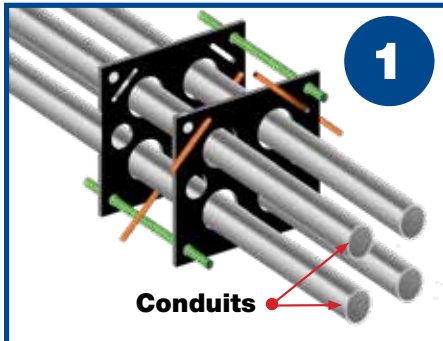

1. Align QwikDuct close to manhole or vault

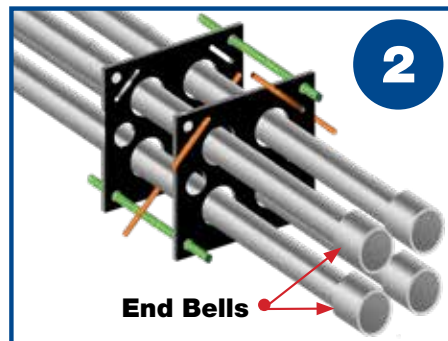

2. Ream out conduits and glue on end bell adapters to each conduit inside or outside manhole or vault

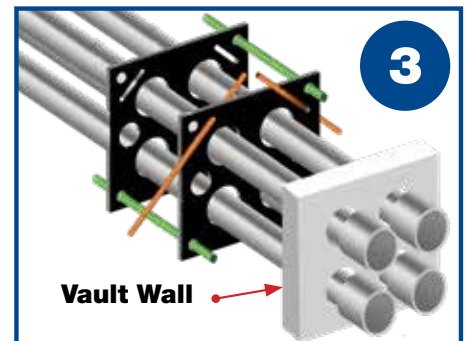

3. Slide conduits with bell end adapters thru manhole openings inside or outside manhole or vault

Customer must satisfy all codes and owners' specifications.



PATENT PENDING
PATENTED



LABELS APPLY TO PRODUCTS ONLY WHERE SHOWN ABOVE

730 Pratt Boulevard • Elk Grove Village, IL 60007
P: (847) 593-8595 • F: (847) 593-8629 • Toll-free (800) 233-8595
E: info@spproducts.com • www.spproducts.com

IP14

Threaded End Bell Adapter

PVC Schedule 40 & 80



NEW!

PATENTED



1/2" thru 6"

Catalog #	Size
PEBAT#50	1/2"
PEBAT#75	3/4"
PEBAT#100	1"
PEBAT#125	1-1/4"
PEBAT#150	1-1/2"
PEBAT#200	2'
PEBAT#250	2-1/2"
PEBAT#300	3"
PEBAT#350	3-1/2"
PEBAT#400	4"
PEBAT#500	5"
PEBAT#600	6"

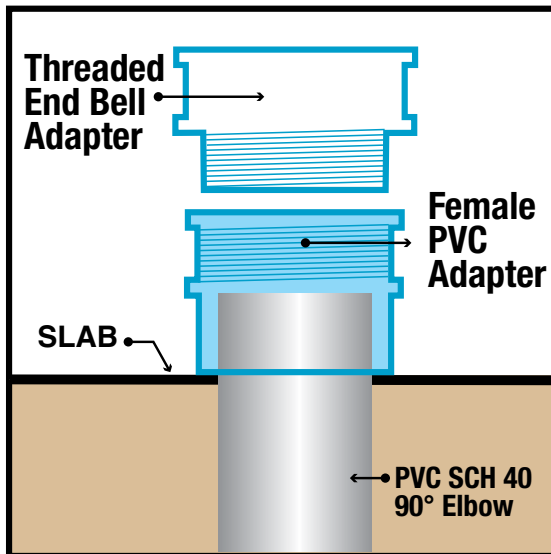

Customer must satisfy all codes and owners' specifications.

SP PRODUCTS, INC
Productivity and value thru ideas



PATENT PENDING
PATENTED



LABELS APPLY TO PRODUCTS ONLY WHERE SHOWN ABOVE

730 Pratt Boulevard • Elk Grove Village, IL 60007
P: (847) 593-8595 • F: (847) 593-8629 • Toll-free (800) 233-8595
E: info@spproducts.com • www.spproducts.com

IP14a

Schedule 40 & 80



PVC Reaming Bits for Transition Couplings

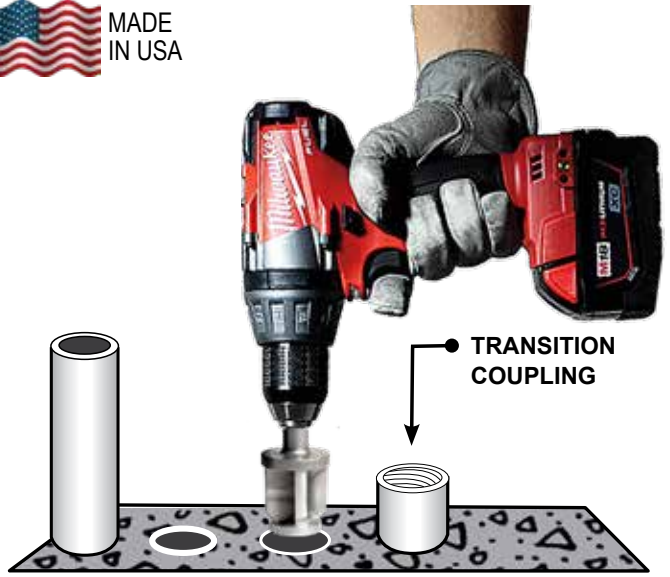

1-Piece

Larger sizes available on special order

1/2" thru 6"

1/2" thru 4"
1/2" Chuck

5" & 6"
3/4" Chuck



PATENT PENDING



High Quality Steel
Sharpenable for Long Life

PVC Conduit Size	SCH 40 PVC Catalog #	PVC Conduit Size	SCH 40 PVC Catalog #
1/2"	IPRB50-SCH 40	2-1/2"	IPRB250-SCH 40
3/4"	IPRB75-SCH 40	3"	IPRB300-SCH 40
1"	IPRB100-SCH 40	3-1/2"	IPRB350-SCH 40
1-1/4"	IPRB125-SCH 40	4"	IPRB400-SCH 40
1-1/2"	IPRB150-SCH 40	5"	IPRB500-SCH 40
2"	IPRB200-SCH 40	6"	IPBR600-SCH 40

PLEASE SPECIFY IF USING FOR SCH 40 OR SCH 80

PVC Conduit Size	SCH 80 PVC Catalog #	PVC Conduit Size	SCH 80 PVC Catalog #
1/2"	IPRB50-SCH 80	2-1/2"	IPRB250-SCH 80
3/4"	IPRB75-SCH 80	3"	IPRB300-SCH 80
1"	IPRB100-SCH 80	3-1/2"	IPRB350-SCH 80
1-1/4"	IPRB125-SCH 80	4"	IPRB400-SCH 80
1-1/2"	IPRB150-SCH 80	5"	IPRB500-SCH 80
2"	IPRB200-SCH 80	6"	IPBR600-SCH 80

NO PARTS TO LOSE ON THE JOB SITE!

Customer must satisfy all codes and owners' specifications.



PATENT PENDING
PATENTED



LABELS APPLY TO PRODUCTS ONLY WHERE SHOWN ABOVE

730 Pratt Boulevard • Elk Grove Village, IL 60007
P: (847) 593-8595 • F: (847) 593-8629 • Toll-free (800) 233-8595
E: info@spproducts.com • www.spproducts.com

IP15

Chamfer Bits

for SCH 40/80 PVC Conduits



Conduit reaming tool smooths wall of conduit with a 30° chamfer around all 360° of conduit to eliminate sharp edges to prevent wire damage and to receive mandrel for wire pull.

Meets utility requirements.
Tool works for both Schedule 40 & 80 .



1-Piece
Larger sizes available
on special order
1/2" thru 6"

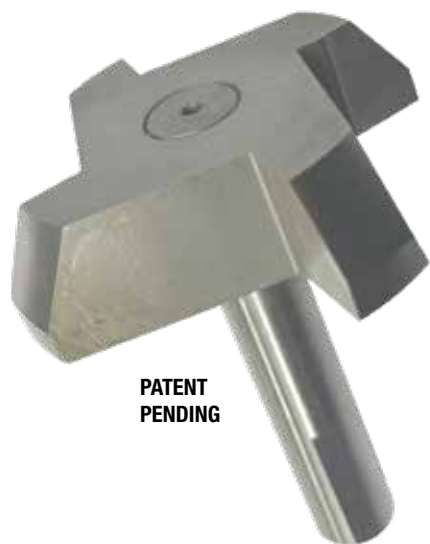

PATENT
PENDING

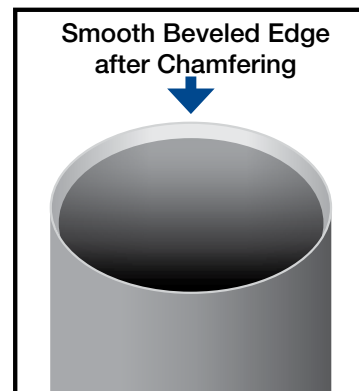

Smooth Beveled Edge
after Chamfering

< Conduit Before

PVC Conduit Size	SCH 40/80 Catalog #	PVC Conduit Size	SCH 40/80 Catalog #
1/2"	CHRB50-SCH 40/80	3"	CHRB300-SCH 40/80
3/4"	CHRB75-SCH 40/80	3-1/2"	CHRB350-SCH 40/80
1"	CHRB100-SCH 40/80	4"	CHRB400-SCH 40/80
1-1/4"	CHRB125-SCH 40/80	5"	CHRB500-SCH 40/80
1-1/2"	CHRB150-SCH 40/80	6"	CHRB600-SCH 40/80
2"	CHRB200-SCH 40/80	8"	CHRB800-SCH 40/80
2-1/2"	CHRB250-SCH 40/80		

Customer must satisfy all codes and owners' specifications.



PATENT PENDING
PATENTED



LABELS APPLY TO PRODUCTS ONLY WHERE SHOWN ABOVE

730 Pratt Boulevard • Elk Grove Village, IL 60007
P: (847) 593-8595 • F: (847) 593-8629 • Toll-free (800) 233-8595
E: info@spproducts.com • www.spproducts.com

IP15a



Chamfer Bits

for Aluminum & Galvanized Rigid Conduit



- Deburrs at any location
- Provides smooth chamfer
- Safer, Better & Faster
- Works with any type of drill with 1/2" chuck



4 Lobes
Conduit Sizes
1/2" thru
2-1/2"

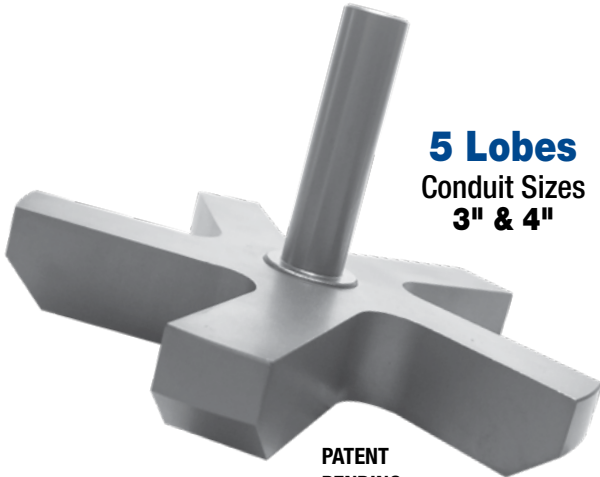

5 Lobes
Conduit Sizes
3" & 4"

PATENT
PENDING

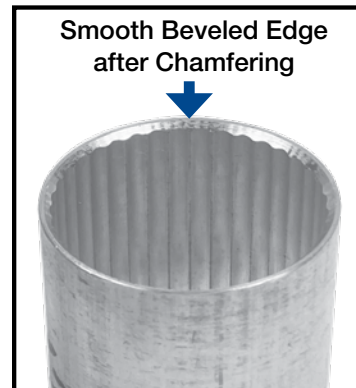

Catalog #	Conduit Size
ALCE-50-75-100	1/2"-3/4"-1"
ALCE-125-150	1-1/4"-1-1/2"
ALCE-200-250	2"-2-1/2"
ALCE-300-350	3"-3-1/2"
ALCE-400	4"

Customer must satisfy all codes and owners' specifications.



PATENT PENDING
PATENTED



LABELS APPLY TO PRODUCTS ONLY WHERE SHOWN ABOVE

730 Pratt Boulevard • Elk Grove Village, IL 60007
P: (847) 593-8595 • F: (847) 593-8629 • Toll-free (800) 233-8595
E: info@spproducts.com • www.spproducts.com

IP16



No Center Stop Slide On Couplings

Joins Conduit Lengths in Difficult Situations

NEW

Allows flexibility of movement for fast, easy installation of conduit in tight, difficult situations.

PATENT PENDING
UL LISTED FOR 3/4, 1, 2 & 4 inch
UL514B & CSA C22.2 No. 18.3
(other sizes pending)

Completely smooth inside diameter with smooth bottomed adjustable center screw. No sharp edges to damage wire during pull.



1. Slide coupling over end of one conduit
2. Line up 2nd conduit and mark it to allow coupling to be slid back and centered over both conduits.
3. Slide coupling back to mark.
4. Tighten $\frac{3}{8}$ " hex head bolts and conduits are securely joined together at center of coupling.
5. Size $\frac{1}{2}$ thru 2 inch = one bolt sizes $2\frac{1}{2}$ and larger = 2 bolts at a 45° angle on each end

SIZE	CAT#	SIZE	CAT#
1/2"	NCSC-50EMT	2"	NCSC-200EMT
3/4"	NCSC-75EMT	2-1/2"	NCSC-250EMT
1"	NCSC-100EMT	3"	NCSC-300EMT
1-1/4"	NCSC-125EMT	3-1/2"	NCSC-350EMT
1-1/2"	NCSC-150EMT	4"	NCSC-400EMT

(Rigid Conduit Version Available Soon - Consult Factory)

Prevent Injury and Save Hours

Customer must satisfy all codes and owners' specifications.



PATENT PENDING
PATENTED



LABELS APPLY TO PRODUCTS ONLY WHERE SHOWN ABOVE

730 Pratt Boulevard • Elk Grove Village, IL 60007
P: (847) 593-8595 • F: (847) 593-8629 • Toll-free (800) 233-8595
E: info@spproducts.com • www.spproducts.com

IP17

Masonry Box Brackets

For 6, 8, 10 & 12 inch depth block walls



Strong 18 Gauge Galvanized Steel

Heat Treated or Stainless Steel also available

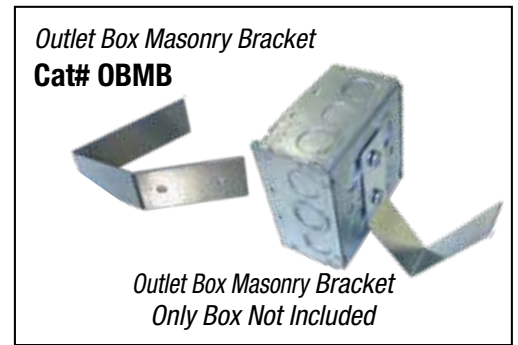

Customer must specify complete catalog numbers when ordering

- Bracket with box and connectors attached available as assembly
- Snaps on Box in seconds and firmly secures it in place.
- Taping available to keep water or mud out of box.
- Eliminate time lost, and code violations when water and mud enter the box plus aggravation when attempting to keep boxes properly aligned with glue, sticks, crushed paper, etc. and not solve the problem.



Save more than 20 minutes per box

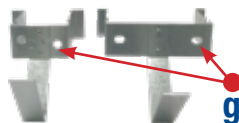

Brackets allow installing ground screws in back of box

Masonry Box Brackets		
Box	Depth	Catalog #
1 Gang	6 inch	1GMBB-6
1 Gang	8 inch	1GMBB-8
1 Gang	10 inch	1GMBB-10
1 Gang	12 inch	1GMBB-12
2 Gang	6 inch	2GMBB-6
2 Gang	8 inch	2GMBB-8
2 Gang	10 inch	2GMBB-10
2 Gang	12 inch	2GMBB-12
Outlet	6 inch	OBMB-6
Outlet	8 inch	OBMB-8
Outlet	10 inch	OBMB-10
Outlet	12 inch	OBMB-12

Customer must satisfy all codes and owners' specifications.



**PATENT PENDING
PATENTED**



LABELS APPLY TO PRODUCTS ONLY WHERE SHOWN ABOVE

730 Pratt Boulevard • Elk Grove Village, IL 60007
 P: (847) 593-8595 • F: (847) 593-8629 • Toll-free (800) 233-8595
 E: info@spproducts.com • www.spproducts.com

IP18

Adjustable Back Box Support



Extremely Strong & Fast Installation Snaps Onto Box in Seconds

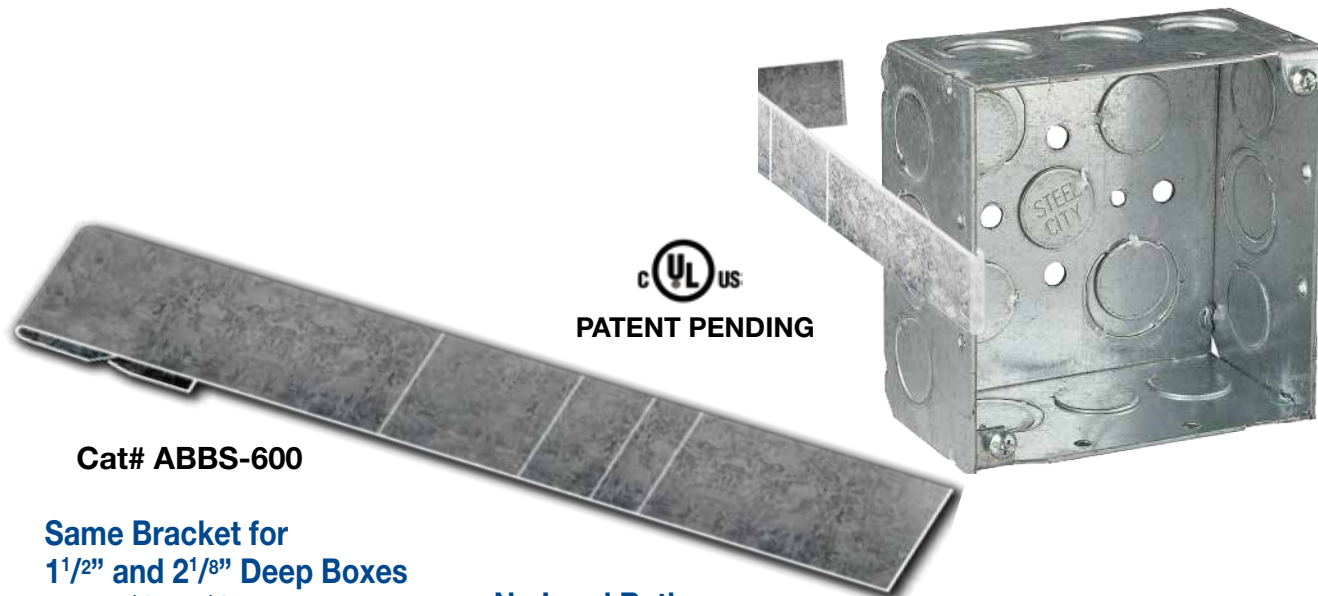

Cat# ABBS-600

Same Bracket for
1 1/2" and 2 1/8" Deep Boxes
Plus 2 1/2", 3 1/2", 4" & 6"
Stud Wall Depths

22 Gauge Galvanized or
Stainless Steel

No Load Rating
(for Position Only)

Standard Package Quantity
100 pcs. per Box

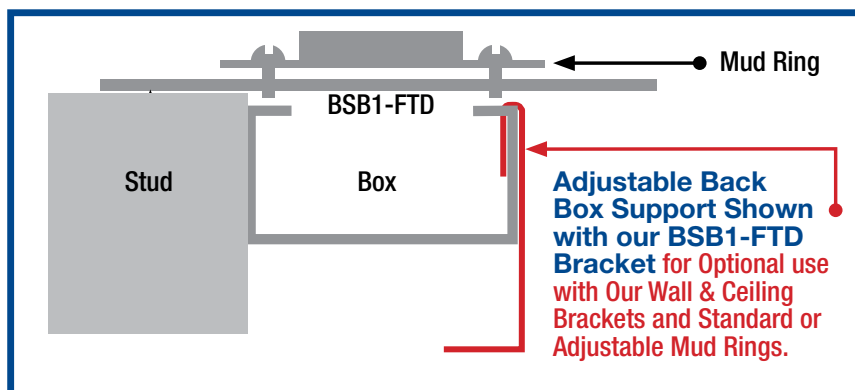

Compatible for Use with Our "Big O" and Fixed Position Brackets

Customer must satisfy all codes and owners' specifications.

SP PRODUCTS, INC
Productivity and value thru ideas



PATENT PENDING
PATENTED

LABELS APPLY TO PRODUCTS ONLY WHERE SHOWN ABOVE



730 Pratt Boulevard • Elk Grove Village, IL 60007
P: (847) 593-8595 • F: (847) 593-8629 • Toll-free (800) 233-8595
E: info@spproducts.com • www.spproducts.com

IP18a

**Strong
ALMAG 535
Material**

4-Conduit Block

Support From Only One Rod



**Threaded Block
for Vertical Rod**

OR

**Threadless Block
for Vertical Rod**

For Vertical Rod 1/4", 3/8" or 1/2"

*Specify bolt size 1/4" or 3/8"
required for the conduit clamp*

ST=(side thread) 1/4" or 3/8"

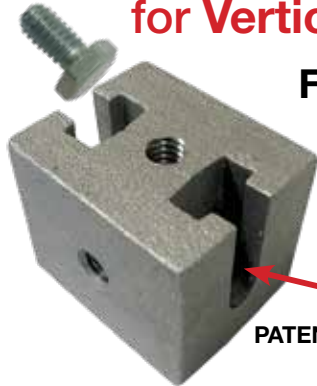

*Bolt Hex
Head Slides
into Slot*

PATENTED

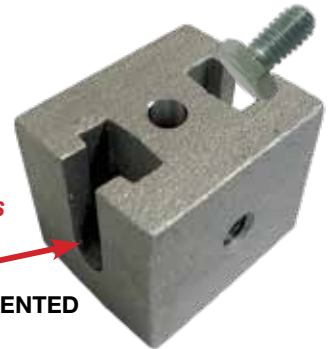

*Bolt Hex
Head Slides
into Slot*

PATENTED

**Standard Slots 1/4"
3/8" Available Upon Request**

THREADED BLOCK	NON-THREADED BLOCKS
1/4 inch rod = Cat# TBT25-ST25	1/4 inch rod = Cat# TBT25-NT-ST25
1/4 inch rod = Cat# TBT25-ST38	1/4 inch rod = Cat# TBT25-NT-ST38
3/8 inch rod = Cat# TBT38-ST25	3/8 inch rod = Cat# TBT38-NT-ST25
3/8 inch rod = Cat# TBT38-ST38	3/8 inch rod = Cat# TBT38-NT-ST38
1/2 inch rod = Cat# TBT50-ST25	1/2 inch rod = Cat# TBT50-NT-ST25
1/2 inch rod = Cat# TBT50-ST38	1/2 inch rod = Cat# TBT50-NT-ST38



1

Insert
Threaded or
Threadless
Rod



2

Drop Hex Heads
into Slots to
Attach Minis



3

Attach Minis
Tighten Nuts

FAST & EASY TO INSTALL

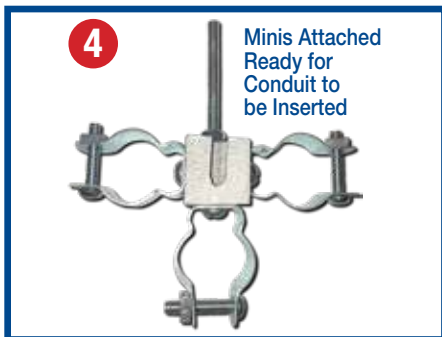

4

Minis Attached
Ready for
Conduit to
be Inserted

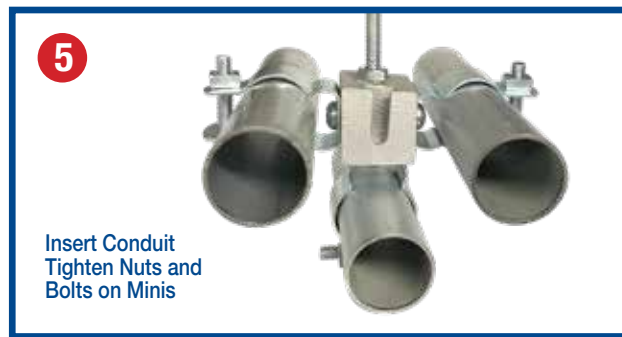

5

Insert Conduit
Tighten Nuts and
Bolts on Minis

Customer must satisfy all codes and owners' specifications.

SP PRODUCTS, INC
Productivity and value thru ideas



**PATENT PENDING
PATENTED**

LABELS APPLY TO PRODUCTS ONLY WHERE SHOWN ABOVE



730 Pratt Boulevard • Elk Grove Village, IL 60007
P: (847) 593-8595 • F: (847) 593-8629 • Toll-free (800) 233-8595
E: info@spproducts.com • www.spproducts.com

IP19

NEW

4-Conduit Block



Support From Only One Rod

For Threaded Vertical Rod
1/4", 3/8" or 1/2"

Specify Bolt Size
1/4" or 3/8"
Required for the
Conduit Clamp



4 threaded holes on 4 sides (no slots)

PATENTED

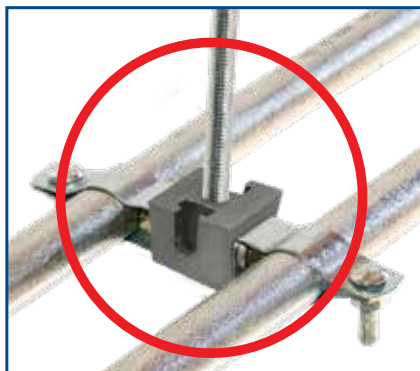

Install larger conduit overhead with our patented 4 conduit threaded support block.

THREADED BLOCK	
1/4 inch rod = Cat# TBT25-ST25	
1/4 inch rod = Cat# TBT25-ST38	
3/8 inch rod = Cat# TBT38-ST25	
3/8 inch rod = Cat# TBT38-ST38	
1/2 inch rod = Cat# TBT50-ST25	
1/2 inch rod = Cat# TBT50-ST38	

NON-THREADED BLOCKS	
1/4 inch rod = Cat# TBT25-NT-ST25	
1/4 inch rod = Cat# TBT25-NT-ST38	
3/8 inch rod = Cat# TBT38-NT-ST25	
3/8 inch rod = Cat# TBT38-NT-ST38	
1/2 inch rod = Cat# TBT50-NT-ST25	
1/2 inch rod = Cat# TBT50-NT-ST38	

Customer must satisfy all codes and owners' specifications.



PATENT PENDING
PATENTED



LABELS APPLY TO PRODUCTS ONLY WHERE SHOWN ABOVE

730 Pratt Boulevard • Elk Grove Village, IL 60007
P: (847) 593-8595 • F: (847) 593-8629 • Toll-free (800) 233-8595
E: info@spproducts.com • www.spproducts.com

IP20



Support Hangers

for Cable Tray, Pipe, Conduit, Light Fixtures and Other Heavy Equipment

Safer – Better – Faster

Eliminates climbing and working above trusses. Install in seconds while standing on deck below.

CAT#	UPPER CHORD
THUC 38	3/8" 1,200 lb Static Load Rating
THUC 50	1/2" 1,200 lb Static Load Rating

CAT#	LOWER CHORD
THLC 38	3/8" 1,200 lb Static Load Rating
THLC 50	1/2" 1,200 lb Static Load Rating

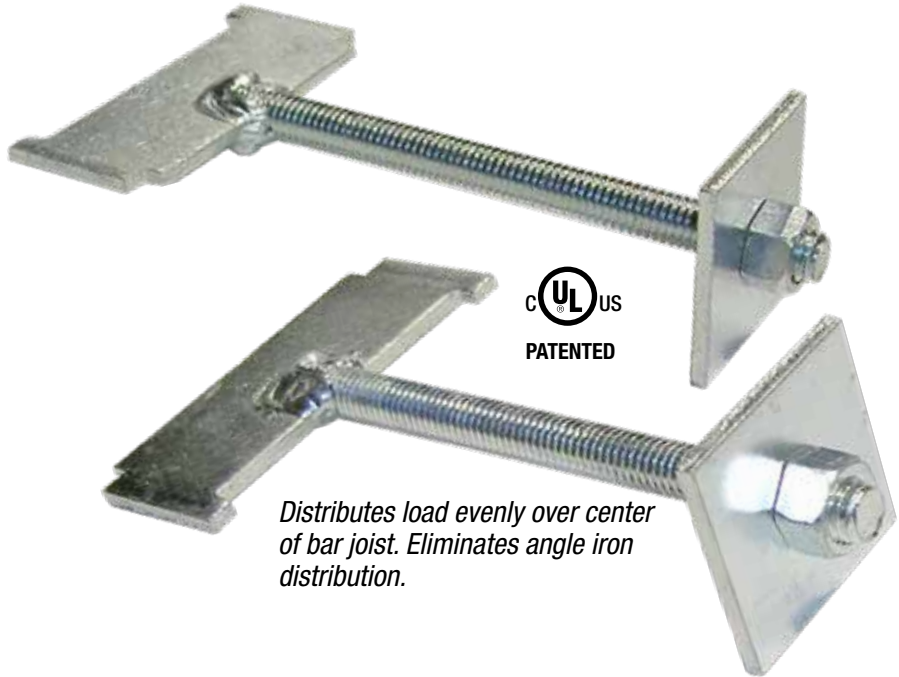

Distributes load evenly over center of bar joist. Eliminates angle iron distribution.



Attach a KLEVIS or other types of readily available hardware

CAT#	KEPS®
THW 38	3/8"
THW 50	1/2"



One piece KEPS® integrated nut/washer firmly locks into chord.

Provides rigid seismic restraint.

Seismic bracing not required when used in top chord applications (9.3.5.3.8 NFPA 13)

Meets UL 514A& CSA C22.2 No. 18.1

Suitable for Supporting Electrical, Fire Suppression, Plumbing, and HVAC Applications in Open Web Bar Joists

Customer must satisfy all codes and owners' specifications.



PATENT PENDING
PATENTED

LABELS APPLY TO PRODUCTS ONLY WHERE SHOWN ABOVE



730 Pratt Boulevard • Elk Grove Village, IL 60007
P: (847) 593-8595 • F: (847) 593-8629 • Toll-free (800) 233-8595
E: info@spproducts.com • www.spproducts.com

IP21

NEW

QwikBlock Box Support

 **MADE
IN USA**

CAT#	QWIKBLOCK
QBBS-25/38	1/4" & 3/8" Threaded Rod
QBBS-50	1/2" Threaded Rod

**Saves
More Than
15
Minutes Per
Installation**

- Accepts 4", 4 11/16" & 5" boxes
- Automatically centers rod
- 1 Nut to lock rod in place
- Eliminates 2 washers, 1 nut and knockout of center KO on back of box
- Install on box with or without plate



Use
4-Conduit Block
(IP19 or IP20)
with QwikBlock
(IP21A)

**ALMAG
535**



• Tapped hole for 1/4"
& 3/8" threaded rod.
Also available for 1/2" rod
(special order only.)

• Attach to box with
(2) 1/4"- 20 x 1/2"
machine screw.

PATENT
PENDING

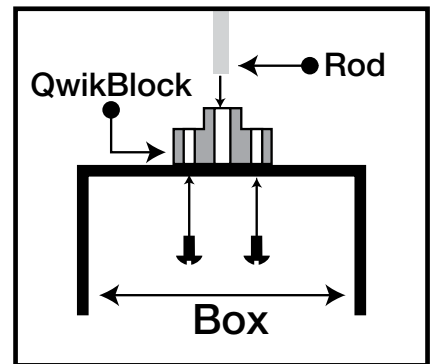

**Works with Our Entire Line of Conduit and
Box Support Plates for Fast and Easy Installation**

Customer must satisfy all codes and owners' specifications.

SP PRODUCTS, INC
Productivity and value thru ideas

 **MADE
IN USA**

 **UL**  **US**

**PATENT PENDING
PATENTED**

LABELS APPLY TO PRODUCTS ONLY WHERE SHOWN ABOVE



730 Pratt Boulevard • Elk Grove Village, IL 60007
P: (847) 593-8595 • F: (847) 593-8629 • Toll-free (800) 233-8595
E: info@spproducts.com • www.spproducts.com

IP21a

Stub Up Slip Coupling



Allows flexibility of movement, slide down over conduit and bolt in place to set Transformers and Gear, Nipple up to Panels etc.

1/2 thru 4 inch Rigid Heavy Wall and PVC Conduit Stubs

SIZE	CAT#
1/2"	SOHWTC 50
3/4"	SOHWTC 75
1"	SOHWTC 100
1-1/4"	SOHWTC 125
1-1/2"	SOHWTC 150
2"	SOHWTC 200
2-1/2"	SOHWTC 250
3"	SOHWTC 300
3-1/2"	SOHWTC 350
4"	SOHWTC 400



PATENTED

Slide on coupling with 5 female threads receive conduit or connectors and 10 male threads for two lock nuts and a ground bushing also available.

- One $\frac{3}{8}$ inch Hex Head Bolt at bottom position for size $\frac{1}{2}$ thru 2 inch Two bolts at a 45° angle for sizes 2½ thru 5 inch
- Bolts can be specifically located at any point to allow greater flexibility

**Safer Installation – Save Hours
Difficult Jobs are Done in Minutes**

Customer must satisfy all codes and owners' specifications.



PATENT PENDING
PATENTED



LABELS APPLY TO PRODUCTS ONLY WHERE SHOWN ABOVE

730 Pratt Boulevard • Elk Grove Village, IL 60007
P: (847) 593-8595 • F: (847) 593-8629 • Toll-free (800) 233-8595
E: info@spproducts.com • www.spproducts.com

IP22

Original Cinch Clamp



Since 1973

- Installed quickly (50% labor savings)
- Competitively Priced
- High strength/heavy duty hot-dipped
- 10-gauge galvanized steel wire.

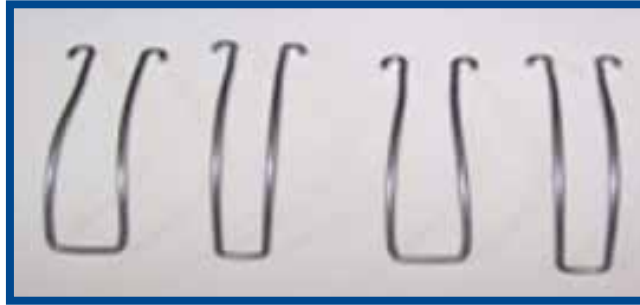

- Only Blade Screwdriver Needed
- Use with all strut type channel
- Securely fits EMT, Rigid, IMC, PVC and pipe
- Also available in stainless steel
- Sizes 1/2 thru 4 inch

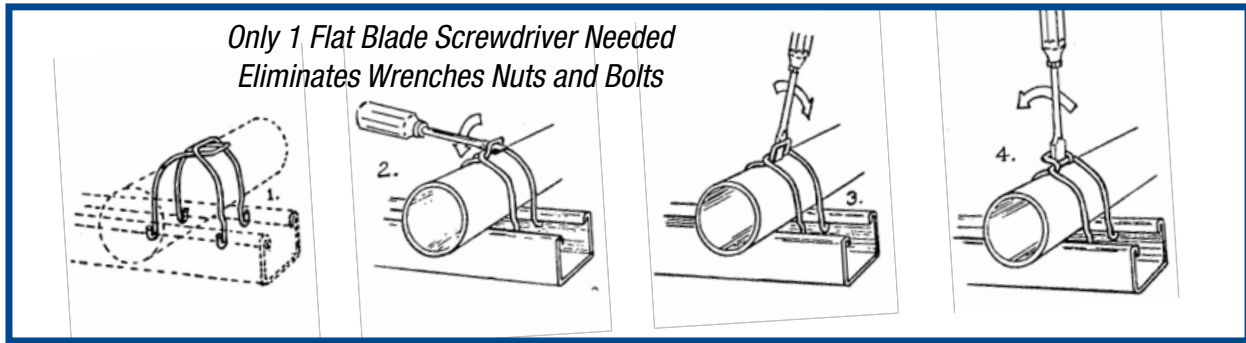

Original Cinch Load Ratings

Trade Size	Metric Designator	Cinch Clamp E-100 Electrical Metallic Tubing (EMT)	Cinch Clamp P-200, SS-300 Rigid Metal Conduit (RMC) Intermediate Metal Conduit (IMC)		Cinch Clamp P-200, SS-300 Rigid PVC Conduit	
		LOAD RATING (lb) Horizontal (Alternate Nomenclature)	LOAD RATING (lb) Horizontal P-200 (Alternate Nomenclature)	LOAD RATING (lb) Horizontal SS-300 (Alternate Nomenclature)	LOAD RATING (lb) Horizontal P-200 (Alternate Nomenclature)	LOAD RATING (lb) Horizontal SS-300 (Alternate Nomenclature)
1/2"	(16)	333(E-12)	333(P-12)	333(P-12)	333(P-12)	333(P-12)
3/4"	(21)	100(E-34)	333(P-34)	333(P-34)	333(P-34)	333(P-34)
1"	(27)	333(E-100)	100(P-100)	333(P-100)	100(P-100)	333(P-100)
1-1/4"	(35)	333(E-114)	333(P-114)	333(P-114)	333(P-114)	333(P-114)
1-1/2"	(41)	333(E-112)	100(P-112)	333(P-112)	100(P-112)	333(P-112)
2"	(53)	333(E-200)	100(P-200)	333(P-200)	100(P-200)	333(P-200)
2-1/2"	(63)		333(P-212)	333(P-212)	333(P-212)	333(P-212)
3"	(78)		333(P-300)	333(P-300)	333(P-300)	333(P-300)
3-1/2"	(91)		333(P-312)	333(P-312)	333(P-312)	333(P-312)
4"	(103)		333(P-400)	333(P-400)	333(P-400)	333(P-400)

Horizontal support intervals are limited to 3.05 m (10 ft) maximum.
Suitable for use in plenums.

INTENDED MOUNTING ORIENTATION - HORIZONTAL

Catalog #	Size	EMT OD	PIPE OD	Load	Load SS*
CC-50	1/2"	.706	.840	333 lbs	333 lbs
CC-75	3/4"	.922	1.050	100 lbs	333 lbs
CC-100	1"	1.163	1.315	333 lbs	100 lbs
CC-125	1 1/4"	1.510	1.660	333 lbs	333 lbs
CC-150	1 1/2"	1.740	1.900	333 lbs	100 lbs
CC-200	2"	2.197	2.375	333 lbs	100 lbs
CC-250	2 1/2"	NA	2.875	NA	333 lbs
CC-300	3"	NA	3.500	NA	333 lbs
CC-350	3 1/2"	NA	4.000	NA	333 lbs
CC-400	4"	NA	4.500	NA	333 lbs

*SS = Stainless Steel

Quick Application Saves Time and Money!

Customer must satisfy all codes and owners' specifications.



PATENT PENDING
PATENTED



LABELS APPLY TO PRODUCTS ONLY WHERE SHOWN ABOVE

730 Pratt Boulevard • Elk Grove Village, IL 60007
P: (847) 593-8595 • F: (847) 593-8629 • Toll-free (800) 233-8595
E: info@spproducts.com • www.spproducts.com

IP23

Box Support Bracket for Fire Alarm, Speakers, Strobes, etc.



8 Inches on Center (as shown)
12 Inches on Center (available upon request)

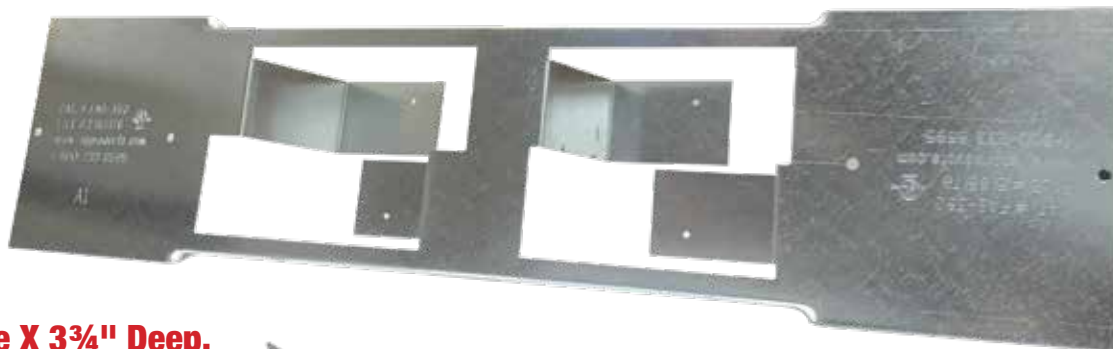

Accepts
3¾" Square X 3¾" Deep,
4" Square X 2⅞" Deep AND
4" Square X 3¾" Deep Boxes.

Ideal for installing in one or two layers of drywall or when adding paneling.

Save More Than 30 MINUTES with a Perfect Installation Every Time!

CAT#	
FAB-350	16" thru 24" thru Stud Spacing

16 Gauge Galvanized or Stainless Steel

- *Wide Flanges allow supporting boxes in from 15 thru 25 inches stud span.*
- *Strong 16 gauge galvanized or stainless steel will not bend or bow during installation.*
- *Quantity discounts and **LABOR ONLY ORDERS** with wiring assemblies installed (customer supplies material other than SP propriety items) available for greater savings.*

Box Available as a Separate Item



Also available with or without 1 piece 3-½" deep red painted boxes

Customer must satisfy all codes and owners' specifications.



PATENT PENDING PATENTED



LABELS APPLY TO PRODUCTS ONLY WHERE SHOWN ABOVE

730 Pratt Boulevard • Elk Grove Village, IL 60007
 P: (847) 593-8595 • F: (847) 593-8629 • Toll-free (800) 233-8595
 E: info@spproducts.com • www.spproducts.com

IP24

Original "Big O"



Indented Box Support Bracket

Mount Boxes and Move Them to Any Location Between Studs

Save More Than 30 MINUTES with Perfectly Level Installation

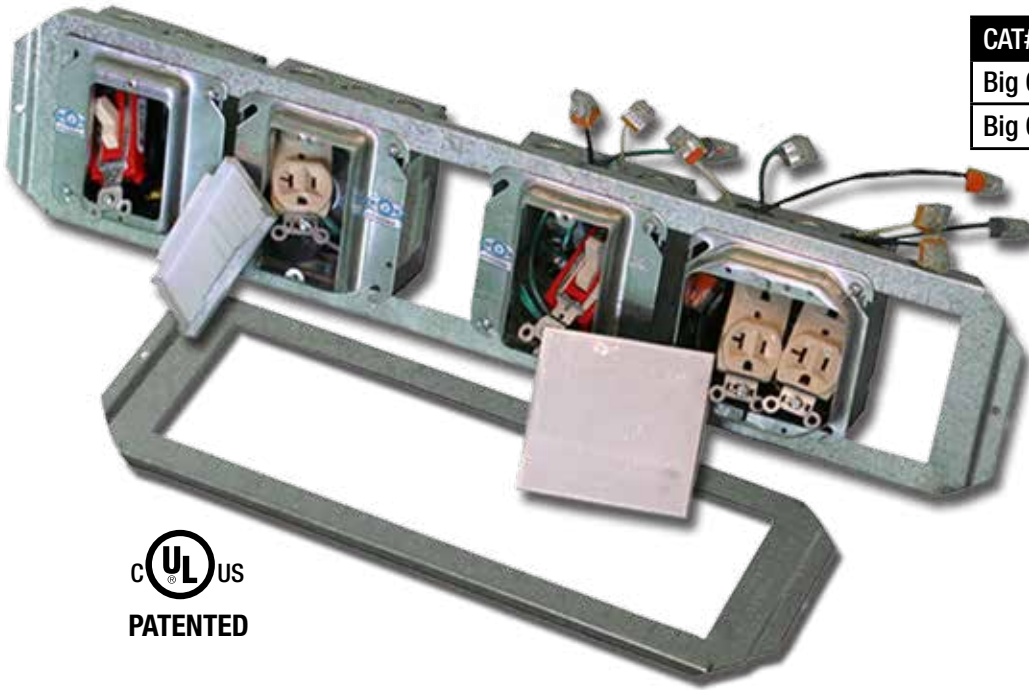

CAT#	BIG "O"	Qty/Box	Wt.
Big O-16	16" Stud Spacing	50	22 lbs
Big O-24	24" Stud Spacing	50	33 lbs

20 Gauge Galvanized or Stainless Steel

- Built in ruler top and bottom flange marked every 1/4 inch allows fast, accurate bench loading
- Mount 4 or 4-11/16" square shallow or deep boxes at any location just loosen two screws to quickly relocate boxes without removing them
- Strong 20 gauge galvanized
- Brackets available with wiring device assemblies attached if components are not specified manufacturers' equals will be supplied.

Mud Ring Sandwiches Box to Bracket

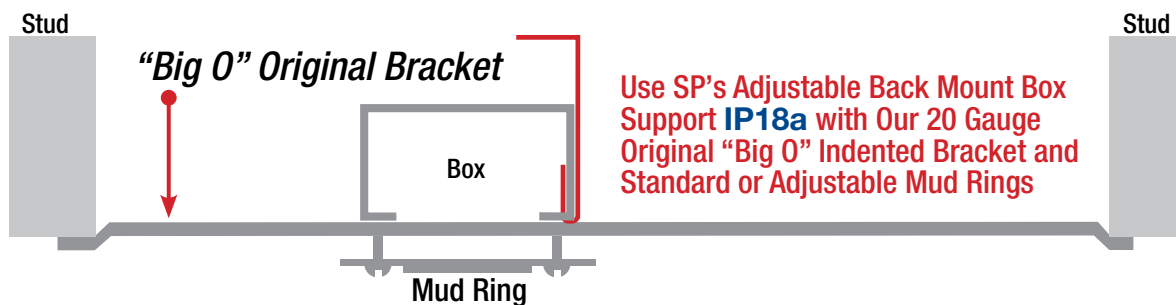

Customer must satisfy all codes and owners' specifications.



**PATENT PENDING
PATENTED**

LABELS APPLY TO PRODUCTS ONLY WHERE SHOWN ABOVE



730 Pratt Boulevard • Elk Grove Village, IL 60007
 P: (847) 593-8595 • F: (847) 593-8629 • Toll-free (800) 233-8595
 E: info@spproducts.com • www.spproducts.com

IP25



Save More Time with a Perfectly Level Installation

“Big O” Flat Box Support Bracket for Stud Walls

Flat version allows bracket to be slid left or right over face of studs for adjustment if necessary and installed with only 1 screw at each end plus enables boxes to be slid left or right to any location between studs.

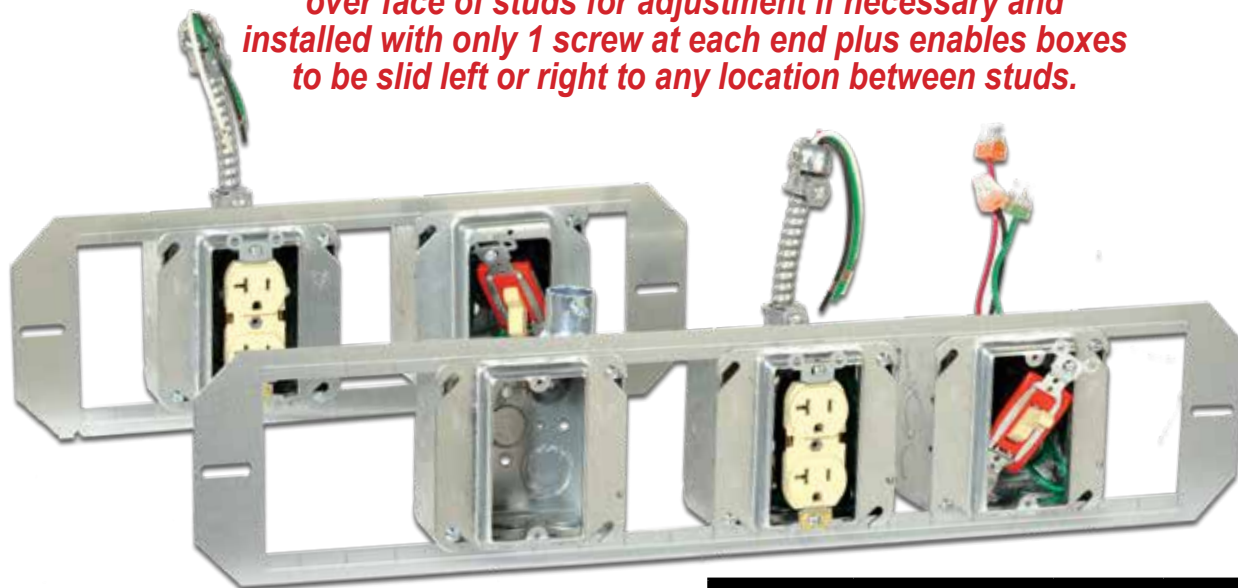

Extra strong 16 gauge galvanized or stainless steel to avoid bending or bowing during installation.

“BIG O” Flat Box Support Bracket 16 Gauge Galvanized or Stainless Steel			
CAT#	Description	Qty/Box	Weight
Big O-16F	16” Stud Spacing	50	22 lbs.
Big O-24F	24” Stud Spacing	50	35 lbs.

UL US
PATENT PENDING

- *Extra strong 16 gauge galvanized or stainless steel to avoid bending or bowing during installation.*
- *Install **4", 4 11/16" and 5"** square boxes, then quickly slide left or right to any location between studs.*
- *Completely flat with NO 1/4" returns on top and bottom of entire width or 3/16" deep offsets at each end.*



Mud Ring Sandwiches Box to Bracket

Customer must satisfy all codes and owners' specifications.

SP PRODUCTS, INC
Productivity and value thru ideas



**PATENT PENDING
PATENTED**



LABELS APPLY TO PRODUCTS ONLY WHERE SHOWN ABOVE

730 Pratt Boulevard • Elk Grove Village, IL 60007
P: (847) 593-8595 • F: (847) 593-8629 • Toll-free (800) 233-8595
E: info@spproducts.com • www.spproducts.com

IP26

Dual Wall Box Support



Save More Than 30 MINUTES with a Perfect Installation Every Time!

Install Only 1 vs 2 Supports

Slots at each end allows bracket to be slid left or right over face of studs for adjustment and allows installation with only 1 screw at each end

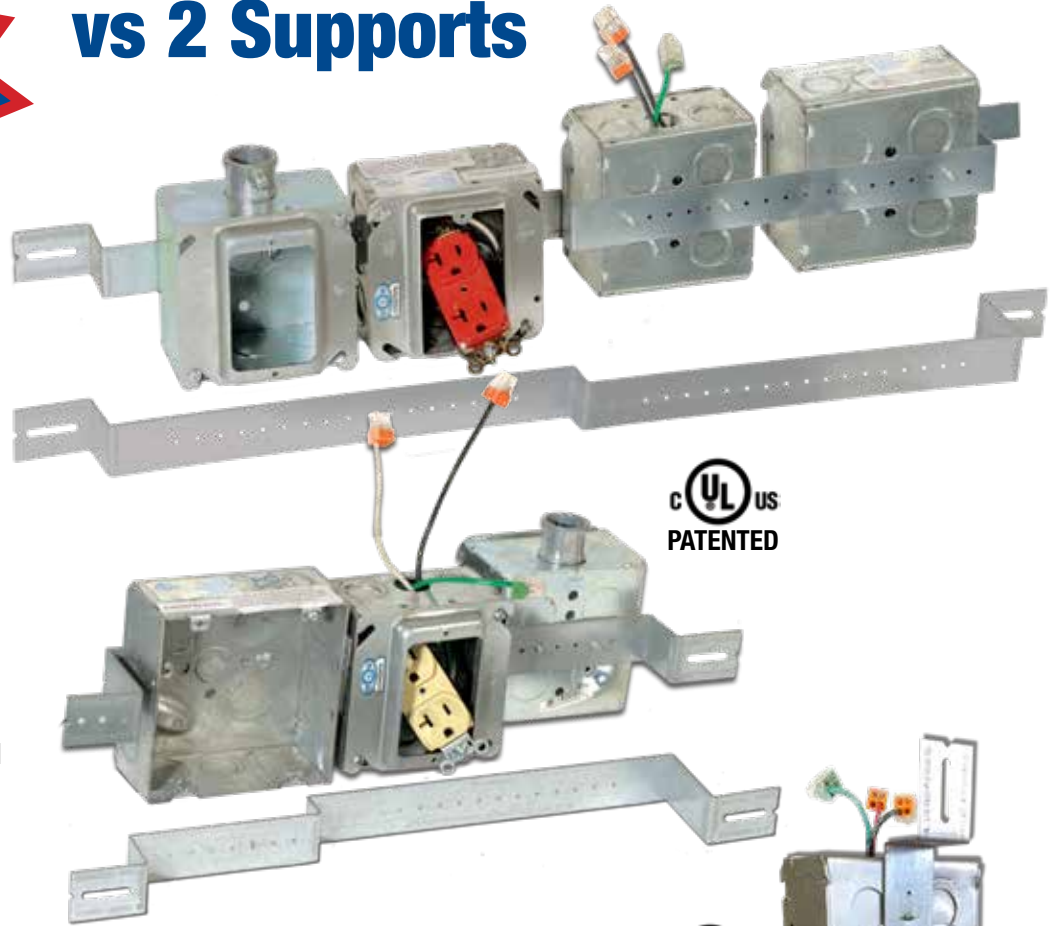

Suitable for 1-1/2" Deep Boxes	
Cat# DSBSWB-24	24" Stud Spacing
<i>supports 2 boxes facing opposite directions on each side of a common wall.</i>	
Cat# DSBSWB-16	16" Stud Spacing
<i>supports 2 boxes on one wall and one in the next room</i>	

16 Gauge Galvanized or Stainless Steel

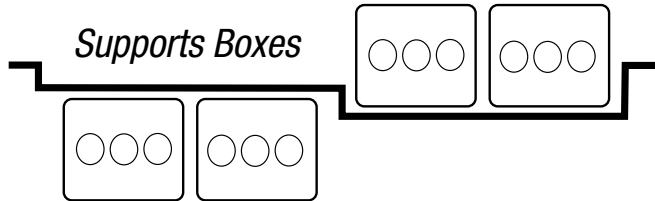

- Holes every 1/2" on center to secure boxes at any location between studs.
- 16 Gauge galvanized or stainless steel
- Brackets available with wiring device assemblies per customer's specifications attached.

Also Supports Boxes Vertically

UL Listed as a Complete Assembly Provided all Components are UL Listed



Customer must satisfy all codes and owners' specifications.



PATENT PENDING PATENTED

LABELS APPLY TO PRODUCTS ONLY WHERE SHOWN ABOVE



730 Pratt Boulevard • Elk Grove Village, IL 60007
 P: (847) 593-8595 • F: (847) 593-8629 • Toll-free (800) 233-8595
 E: info@spproducts.com • www.spproducts.com

IP27

Box Support Wall Bracket



Slide bracket left or right over studs for adjustment and allows installation with only 1 screw at each end

16 Gauge Galvanized or Stainless Steel

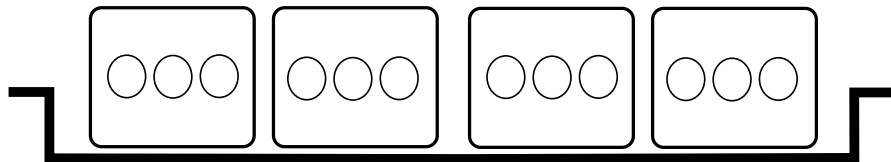

Supports 4", 4^{11/16}" & 5" Square Boxes

Suitable for 1-1/2" Deep Boxes	
Cat# CWB-16-178	16" Stud Spacing -1-1/2" Depth
Cat# CWB-24-178	24" Stud Spacing -1-1/2" Depth
Suitable for 2-1/8" Deep Boxes	
Cat# CWB-16-218	16" Stud Spacing -1-1/8" Depth
Cat# CWB-24-218	16" Stud Spacing -1-1/8" Depth
Suitable for 3-1/2" Deep Boxes	
Cat# CWB-16-278	16" Stud Spacing -3-1/2" Depth
Cat# CWB-24-278	24" Stud Spacing -3-1/2" Depth

Customer must satisfy all codes and owners' specifications.



**PATENT PENDING
PATENTED**



LABELS APPLY TO PRODUCTS ONLY WHERE SHOWN ABOVE

730 Pratt Boulevard • Elk Grove Village, IL 60007
 P: (847) 593-8595 • F: (847) 593-8629 • Toll-free (800) 233-8595
 E: info@spproducts.com • www.spproducts.com

IP27a

Electro Post EP-10 Box Support Bracket



Mounts on all standard stud widths of 2-1/2", 3-5/8", or 6"

MOUNTING INSTRUCTIONS

Step 1

Fold bracket to form square tube post and secure by inserting tabs into slots.

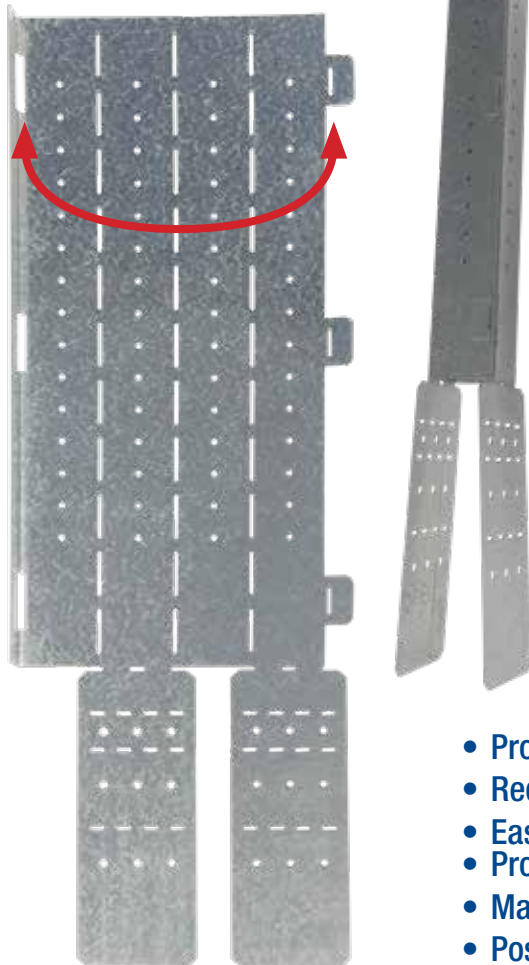

Step 2

Fold bracket mounting flanges to accommodate wall stud width (2-1/2", 3-5/8", or 6").

Step 3

Attach box(es) to either side of EP-10 with standard fasteners.



Step 4

Bracket can be loaded with 4", 4-11/16", square boxes and assembled with boxes and mud rings as required prior to installation (on stud) in prefab shop or on site.

Step 5

Bracket fastened to intended top plate wall stud directly above a vertical stud with (3) #10-16 min 5/8" long Tek screws on each side of bracket to meet UL listing requirements prior to installation of drywall

CAT#	BOX SUPPORT BRACKET
EP-10	2-1/2", 3-5/8" & 6" Studs

24 Gauge Galvanized or Stainless Steel
(50 pcs. per box) 20 lbs



PATENT
PENDING

- Provides uniform height directly above T-Grid Ceiling.
- Reduces electricians working at higher heights on large ladders.
- Easy accessibility thru ceiling to electrical boxes after completion.
- Product ships flat for shipping ease, 50 pcs. per box/20 lbs.
- Made from 24 gauge galvanized or stainless steel.
- Post folds for installation without use of tools.
- Mount electrical boxes to any side of post.

Customer must satisfy all codes and owners' specifications.



PATENT PENDING
PATENTED

LABELS APPLY TO PRODUCTS ONLY WHERE SHOWN ABOVE



730 Pratt Boulevard • Elk Grove Village, IL 60007
P: (847) 593-8595 • F: (847) 593-8629 • Toll-free (800) 233-8595
E: info@spproducts.com • www.spproducts.com

IP27b



Conduit Plug

and ID Tag with Hole for Pull String Protect and Identify Conduit Runs

- On/Off in seconds
- Prevents mistakes
- No debris enters conduit
- Tab allows changing detailed ID several times
- Accommodates three conduit sizes per plug
- Strong, long lasting, and reusable
- Highly visible bright orange only

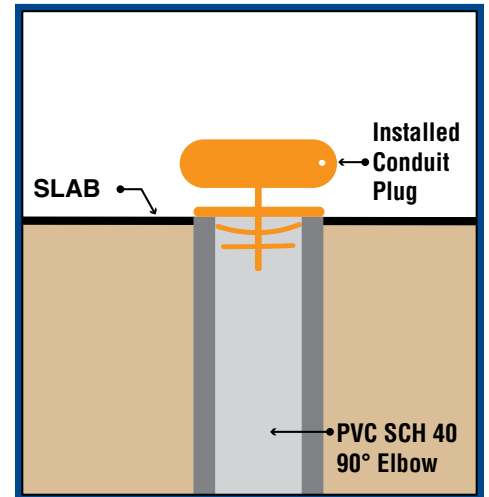
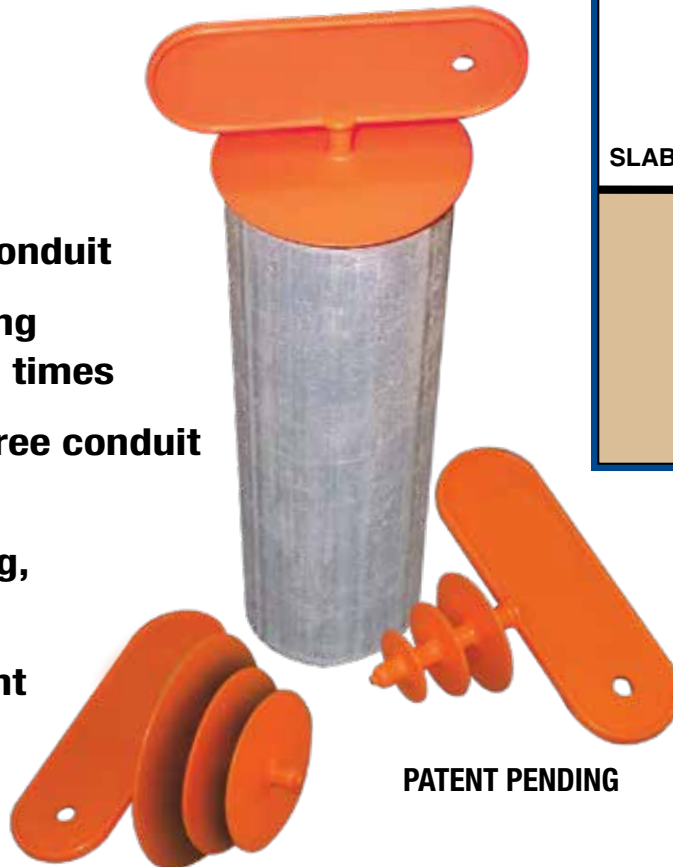

PATENT PENDING

CAT #	SIZE
CP50-75-100	1/2", 3/4", 1"
CP125-150-200	1 1/4", 1 1/2", 2"

Eliminate Problems Plus Save Time and Material on Jobs

Customer must satisfy all codes and owners' specifications.



PATENT PENDING
PATENTED



LABELS APPLY TO PRODUCTS ONLY WHERE SHOWN ABOVE

730 Pratt Boulevard • Elk Grove Village, IL 60007
 P: (847) 593-8595 • F: (847) 593-8629 • Toll-free (800) 233-8595
 E: info@spproducts.com • www.spproducts.com

IP27c



Flat Fixed Position 1 Box Support Bracket

Tear drop shaped mounting holes allow fast & perfect installation of boxes without removing box screws.

Flat version allows bracket to be slid left or right over face of studs for adjustment and allows installation with only 1 screw at each end

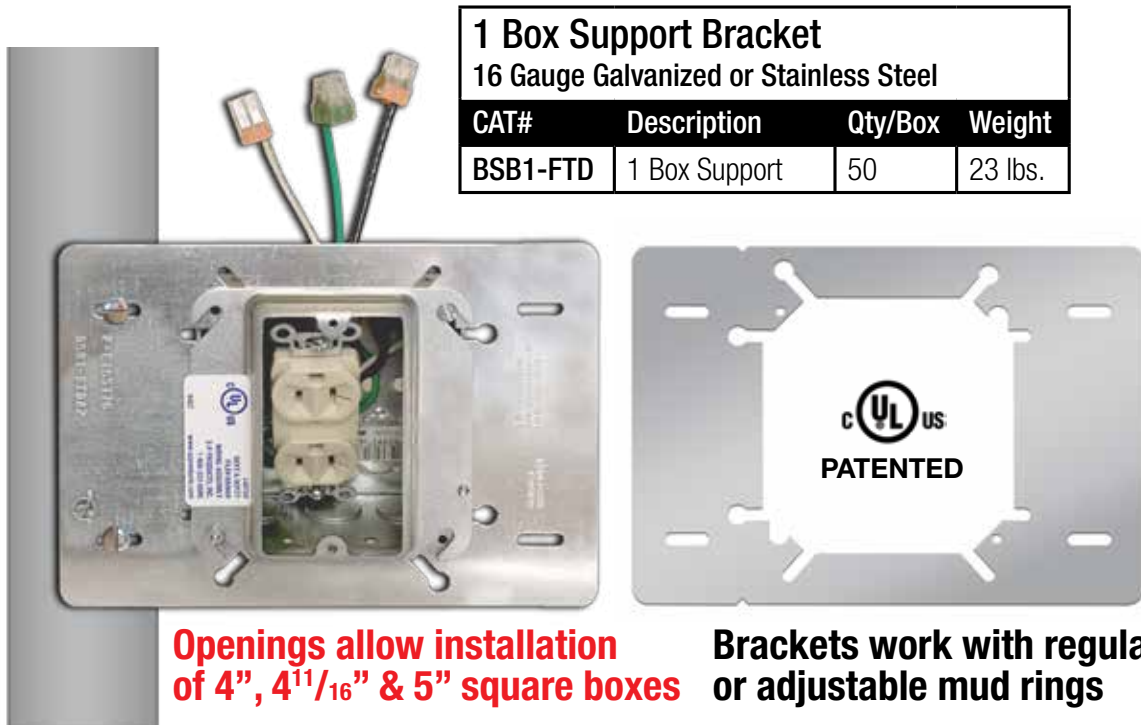

MOUNTING INSTRUCTIONS

- Step 1** Align bracket center line to the stud height location required.
- Step 2** Apply #8 self tapping screw pan head or Phillips thru slots to secure to stud.
- Step 3** Bracket can be loaded with 4", 4¹¹/₁₆" and 5" square boxes and preassembled with boxes and mud rings required prior to installation (on stud) in prefab shop or on site.

Available With or Without Adjustable Mud Rings

Customer must satisfy all codes and owners' specifications.



PATENT PENDING
PATENTED



LABELS APPLY TO PRODUCTS ONLY WHERE SHOWN ABOVE

730 Pratt Boulevard • Elk Grove Village, IL 60007
 P: (847) 593-8595 • F: (847) 593-8629 • Toll-free (800) 233-8595
 E: info@spproducts.com • www.spproducts.com

IP28

Flat Fixed Position 2 Box Support Bracket



Tear drop shaped mounting holes allow fast & perfect installation of boxes without removing box screws.

Flat version allows bracket to be slid left or right over face of studs for adjustment and allows installation with only 1 screw at each end

2 Box Support Bracket			
16 Gauge Galvanized or Stainless Steel			
CAT#	Description	Qty/Box	Weight
BSB2-FTD	2 Box Support	50	49 lbs.

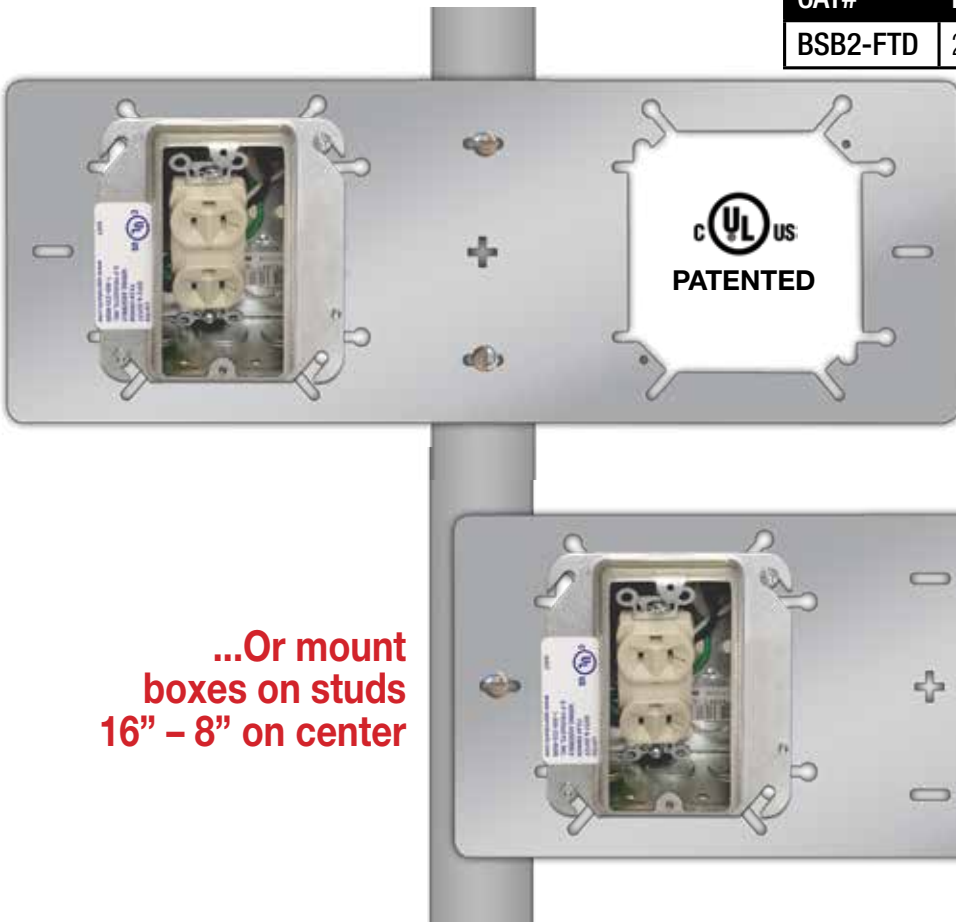

Mount boxes on both sides of stud...

...Or mount boxes on studs 16" - 8" on center

Openings allow installation of 4", 4^{11/16}" & 5" square boxes

Brackets work with regular or adjustable mud rings

Customer must satisfy all codes and owners' specifications.



**PATENT PENDING
PATENTED**



LABELS APPLY TO PRODUCTS ONLY WHERE SHOWN ABOVE

730 Pratt Boulevard • Elk Grove Village, IL 60007
 P: (847) 593-8595 • F: (847) 593-8629 • Toll-free (800) 233-8595
 E: info@spproducts.com • www.spproducts.com

IP28a

Flat Fixed Position 3 Box Support Bracket



Tear drop shaped mounting holes allow fast & perfect installation of boxes without removing box screws.

Flat version allows bracket to be slid left or right over face of studs for adjustment and allows installation with only 1 screw at each end

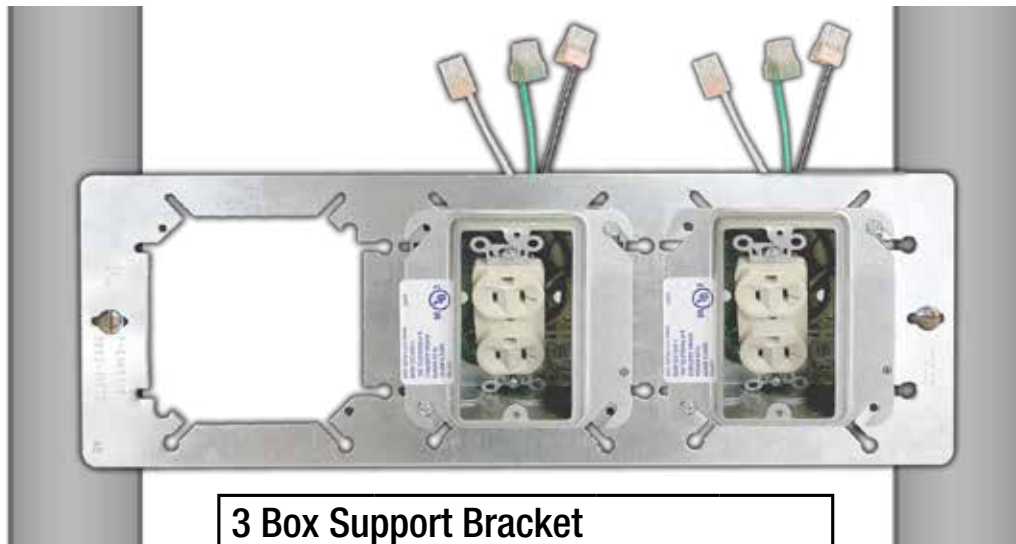
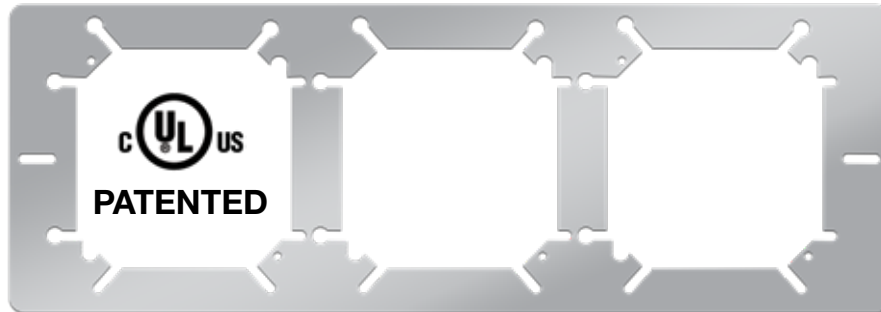

3 Box Support Bracket			
16 Gauge Galvanized or Stainless Steel			
CAT#	Description	Qty/Box	Weight
BSB3-FTD	3 Box Support 16" Stud Spacing	50	34 lbs.

Openings allow installation of 4", 4^{11/16"} & 5" square boxes

Brackets work with regular or adjustable mud rings

Customer must satisfy all codes and owners' specifications.



**PATENT PENDING
PATENTED**



LABELS APPLY TO PRODUCTS ONLY WHERE SHOWN ABOVE

730 Pratt Boulevard • Elk Grove Village, IL 60007
 P: (847) 593-8595 • F: (847) 593-8629 • Toll-free (800) 233-8595
 E: info@spproducts.com • www.spproducts.com

IP28b

Flat Fixed Position 4 Box Support Bracket



Tear drop shaped mounting holes allow fast & perfect installation of boxes without removing box screws.

Flat version allows bracket to be slid left or right over face of studs for adjustment and allows installation with only 1 screw at each end



4 Box Support Bracket			
16 Gauge Galvanized or Stainless Steel			
CAT#	Description	Qty/Box	Weight
BSB4-FTD	4 Box Support 24" Stud Spacing	25	29 lbs.



Openings allow installation of 4", 4^{11/16}" & 5" square boxes

Brackets work with regular or adjustable mud rings

Customer must satisfy all codes and owners' specifications.



**PATENT PENDING
PATENTED**



LABELS APPLY TO PRODUCTS ONLY WHERE SHOWN ABOVE

730 Pratt Boulevard • Elk Grove Village, IL 60007
 P: (847) 593-8595 • F: (847) 593-8629 • Toll-free (800) 233-8595
 E: info@spproducts.com • www.spproducts.com

IP28c

NEW

Custom Mounting Plates



Allow fast perfectly located down lights, boxes or other highly repetitive applications above vanities, desks, etc.

Attach to wall, Hard Lid or T Bar ceilings & quickly drop-boxes, fixtures, etc. in later.

Avoid time consuming repetitive measurements for each installation.

Galvanized Steel



Boxes, mounting bolts, etc. welded to plate to prevent unauthorized access in high security areas;

- Prisons
- Hospitals
- Courthouses
- Airports

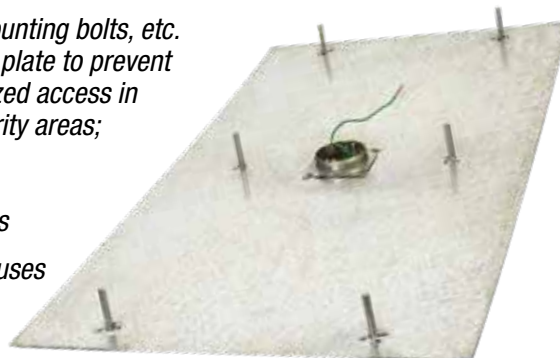

Clear polycarbonate back plates with pre-drilled holes for mounting and installing all types of boxes

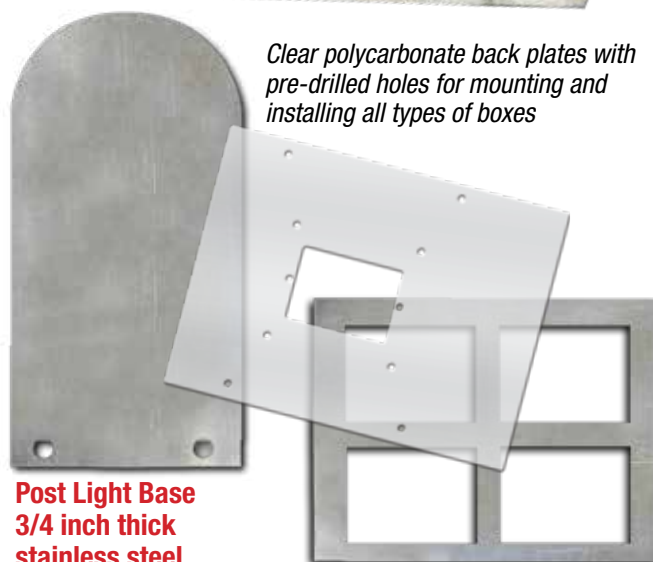

**Post Light Base
3/4 inch thick
stainless steel**

Ganged Boxes

- Eliminate costly time consuming measuring and possible mistakes
- All plates have rounded corners for safer handling and installation.
- **Any configuration & gauge galvanized or stainless steel with any size mounting holes, slots, etc at specified locations Available on special order.**

Excellent Quality at Competitive Prices Tell Us What You Need – We'll Make It!

Customer must satisfy all codes and owners' specifications.



**PATENT PENDING
PATENTED**



LABELS APPLY TO PRODUCTS ONLY WHERE SHOWN ABOVE

730 Pratt Boulevard • Elk Grove Village, IL 60007
P: (847) 593-8595 • F: (847) 593-8629 • Toll-free (800) 233-8595
E: info@spproducts.com • www.spproducts.com

IP29-29a

Slicknut



Bushing Adapters for Pulling & Grounding Wire

**Sizes
1/2 thru
4 inch**

IP30a

THREADED GROUND BUSHING

Threaded Ground Bushing
CAT# TGB 50-400 Series



IP30b

THREADLESS GROUND BUSHING

Threadless Ground Bushing
CAT# NTGB 50-400 Series



(Standard Qwik Nut includes 1 Lug)
Must install 3 Lugs for UL Listing,
extra lugs sold separately.
Consult Factory for prices and availability

Rounded edge prevents damage to wire during pulls
Threadless versions for use with heavy wall and thin wall conduit
3 Holes 120° on centers to receive tapped lugs

Threaded Ground Bushing
CAT# NTGB 50-400 Series



SLICKNUT SOCKET TOOL **NEW**

Socket to securely install
Slicknut bushings

Customer must satisfy all codes and owners' specifications.



PATENT PENDING
PATENTED



LABELS APPLY TO PRODUCTS ONLY WHERE SHOWN ABOVE

730 Pratt Boulevard • Elk Grove Village, IL 60007
P: (847) 593-8595 • F: (847) 593-8629 • Toll-free (800) 233-8595
E: info@spproducts.com • www.spproducts.com

IP30



Slicknut

Bushing Adapters for Pulling Wire

**Sizes
1/2 thru
4 inch**

IP31a

THREADED PULL BUSHING

Threaded Ground Bushing
CAT# TPB 50-400 Series



IP31b

THREADLESS PULL BUSHING

Threaded Ground Bushing
CAT# NTPB 50-400 Series



(Standard Qwik Nut includes 1 Lug)
Must install 3 Lugs for UL Listing,
extra lugs sold separately.
Consult Factory for prices and availability

**Rounded edge prevents damage to wire during pulls
Saves time when pulling branch & feeder wire
Serrated edge on under side of bushing serve as locknut
Split plastic bushing also serves as locknut
Install one with every connector**

Threaded Ground Bushing
CAT# NTGB 50-400 Series



**SLICKNUT
SOCKET TOOL** **NEW**
Socket to securely install
Slicknut bushings

Customer must satisfy all codes and owners' specifications.



PATENT PENDING
PATENTED



LABELS APPLY TO PRODUCTS ONLY WHERE SHOWN ABOVE

730 Pratt Boulevard • Elk Grove Village, IL 60007
P: (847) 593-8595 • F: (847) 593-8629 • Toll-free (800) 233-8595
E: info@spproducts.com • www.spproducts.com

IP31



EZ Hangers in T Bar Ceilings

For Down Lites, Speakers, Exit Signs, etc.



Save over **20 MINUTES** per installation with a **PERFECT ALIGNMENT EVERY TIME!**



E180245

CAT#	BOX SUPPORT BRACKET
2B1	2 Foot (24" on Center) T Bar Sold in Pairs
4B1	4 Foot (48" on Center) T Bar Sold in Pairs

- **Extremely strong 22 gauge galvanized steel with a 50 lb load rating.**
- No extra parts to drop or lose.
- 2 mounting holes each 1-½ inch from center mark to quickly mount speakers or other devices in center of tile plus one at each end for supporting to structure independently of T Bar per IFFX Luminaire Fittings Standard.

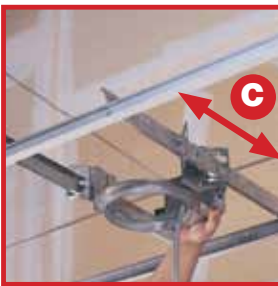
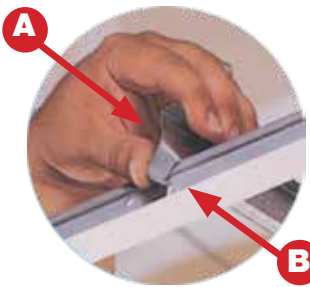
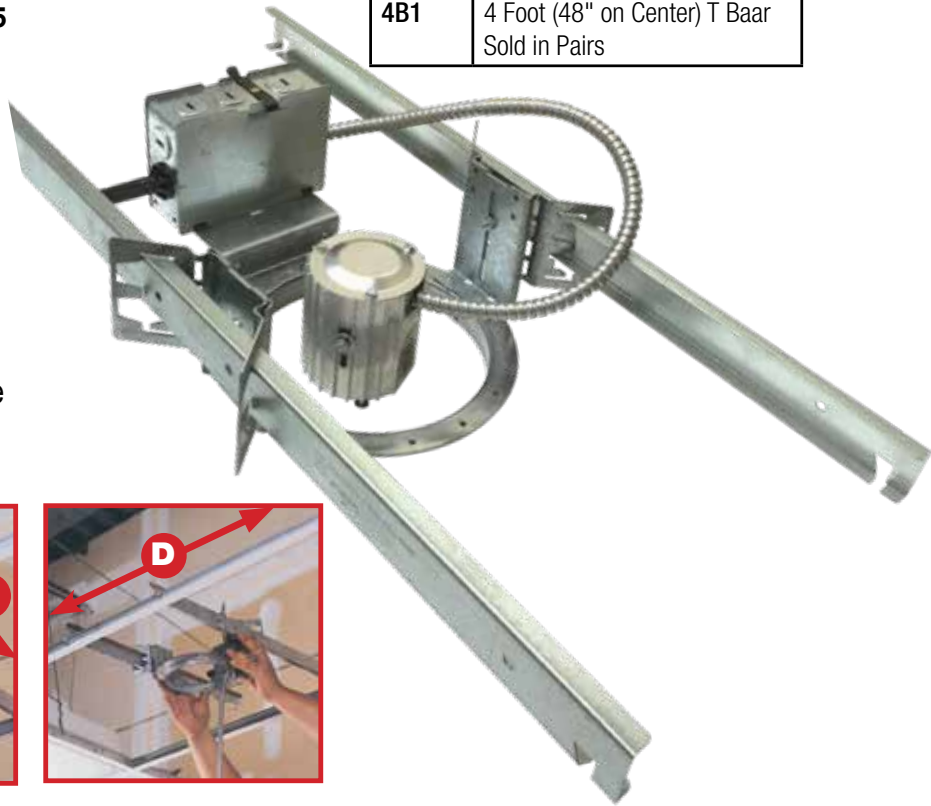

A Bend out tabs on ends of hangers

B Bend tabs in to lock in place

C Slide hangers with box or fixture housing attached along T Bar

D Slide fixture housing, boxes, etc. in other direction along hangers to location required

Eliminate Labor Intensive Cutting & Tying Down Lathers Channel, Black Iron, Conduit, etc.

Customer must satisfy all codes and owners' specifications.



PATENT PENDING
PATENTED



LABELS APPLY TO PRODUCTS ONLY WHERE SHOWN ABOVE

730 Pratt Boulevard • Elk Grove Village, IL 60007
P: (847) 593-8595 • F: (847) 593-8629 • Toll-free (800) 233-8595
E: info@spproducts.com • www.spproducts.com

IP32

Plain Mounting Brackets for T Bar Ceilings



**For Down Lites, Speakers,
Exit Signs, boxes etc.**



Attach PB1 brackets to box insert 2B1 or 4B1 hangers for mounting at various elevations in T Bar Ceilings.

CAT#	BOX SUPPORT BRACKET
PB1	Mounting Brackets
22 gauge galvanized or stainless steel	

Customer must satisfy all codes and owners' specifications.



PATENT PENDING
PATENTED



LABELS APPLY TO PRODUCTS ONLY WHERE SHOWN ABOVE

730 Pratt Boulevard • Elk Grove Village, IL 60007
P: (847) 593-8595 • F: (847) 593-8629 • Toll-free (800) 233-8595
E: info@spproducts.com • www.spproducts.com

IP33

Vertical, Ceiling Adjustable Bar Hanger Assembly



Save over
40 MINUTES
per installation with a
PERFECT ALLIGNMENT
EVERY TIME!



**22 gauge galvanized
or stainless steel**

Perfect for Prefab!

**Provides a strong support &
flexibility for critical height
adjustments in T Bar Ceilings**

**Meets 50lb Load
Rating Requirement**



Customer must satisfy all codes and owners' specifications.



**PATENT PENDING
PATENTED**



LABELS APPLY TO PRODUCTS ONLY WHERE SHOWN ABOVE

730 Pratt Boulevard • Elk Grove Village, IL 60007
P: (847) 593-8595 • F: (847) 593-8629 • Toll-free (800) 233-8595
E: info@spproducts.com • www.spproducts.com

IP34

Custom Engraved Nameplates & Labels For Electrical and Mechanical Identification



- *Extensive experience labeling complex redundant base building systems in data centers (tenant labels for PDUs, FDCs, RPPs, cabinet rows, server racks, power strips) and hospitals.*
- *Laser engraved stainless steel, aluminum and plastic signs with vinyl lettering also available.*

Customer must satisfy all codes and owners' specifications.



PATENT PENDING
PATENTED



LABELS APPLY TO PRODUCTS ONLY WHERE SHOWN ABOVE

730 Pratt Boulevard • Elk Grove Village, IL 60007
P: (847) 593-8595 • F: (847) 593-8629 • Toll-free (800) 233-8595
E: info@spproducts.com • www.spproducts.com

IP35

Prefab Assemblies for Data Power Distribution Units



Any Manufacturers' brand, type and configuration of UL Listed components

Cables Satisfy National Electrical Code Article 645.5(E) and do not have to be securely fastened in place and supported every 4.5 feet as stated in article 350.30(A).

Every assembly is carefully and thoroughly tested per customers' requirements for ground integrity, insulation leaks, proper phase rotation and all conductors are Hi-Pots tested at twice rated circuit voltage plus 1,000 volts.

Certificate of calibration provided with each order.

Assemblies are marked at each end with custom labels protected by clear heat shrink tubing to prevent alteration or accidental removing.

Liquidtight conduit colors available in: black, gray, blue, red, yellow, green, orange, brown, and white up thru 225 ft.

Specify all components and if certain manufacturers' brands are required

Single or multiple circuits provided.



Consult factory for prices and availability.

Customer must satisfy all codes and owners' specifications.



PATENT PENDING
PATENTED



LABELS APPLY TO PRODUCTS ONLY WHERE SHOWN ABOVE

730 Pratt Boulevard • Elk Grove Village, IL 60007
P: (847) 593-8595 • F: (847) 593-8629 • Toll-free (800) 233-8595
E: info@spproducts.com • www.spproducts.com

PFA1

Prefab Assemblies



Let SP be Your Prefab Shop with **NO INVESTMENT**
on Every Day Jobs Throughout the Year

**PLUS...Compete Aggressively and
Win Larger Jobs with More Profit**



BSB1-FTD
(See page IP28)

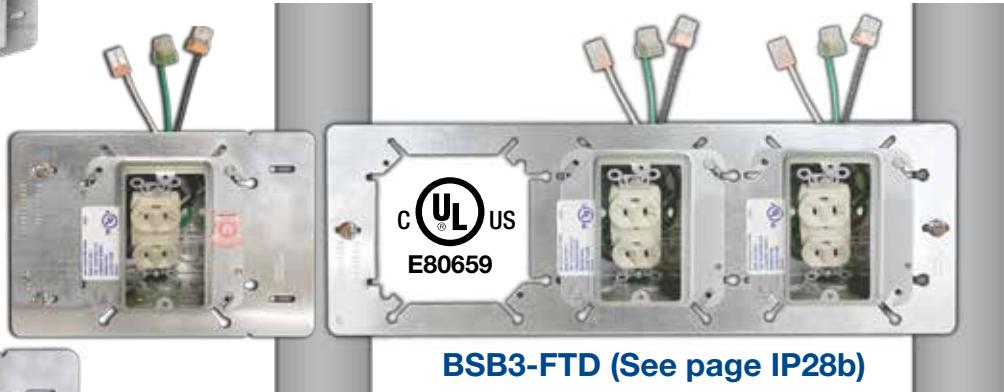

BSB3-FTD (See page IP28b)

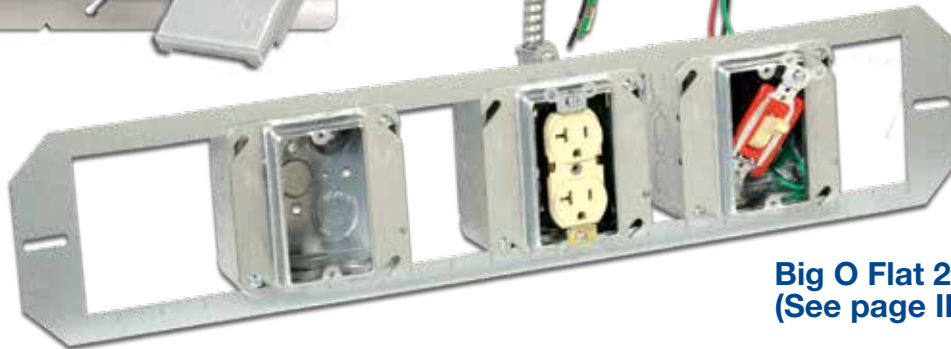

Big O Flat 24F
(See page IP26)

- If components are not specified, manufacturers equals of our choice will be supplied
- Quantity discounts and **LABOR ONLY ORDERS** (customer supplies all material other than SP proprietary items) available for greater savings

PLUS An Unlimited Variety of Other Applications

 <p>Assemblies available with 1 or 2 gang Strong Steel Snap On/Off Protective Covers</p>		 <p>PATENTED E185948 Protective Covers also sold separately (see pg TE-1)</p>
--	---	---

All units carefully inspected, marked and packed to guarantee quality plus minimize handling in the shop or field.

Customer must satisfy all codes and owners' specifications.



**PATENT PENDING
PATENTED**

LABELS APPLY TO PRODUCTS ONLY WHERE SHOWN ABOVE



730 Pratt Boulevard • Elk Grove Village, IL 60007
P: (847) 593-8595 • F: (847) 593-8629 • Toll-free (800) 233-8595
E: info@spproducts.com • www.spproducts.com

PFA2

Prefab Assemblies



Let SP be Your Prefab Shop with **NO INVESTMENT**
on Every Day Jobs Throughout the Year

**PLUS...Compete Aggressively and
Win Larger Jobs with More Profit**

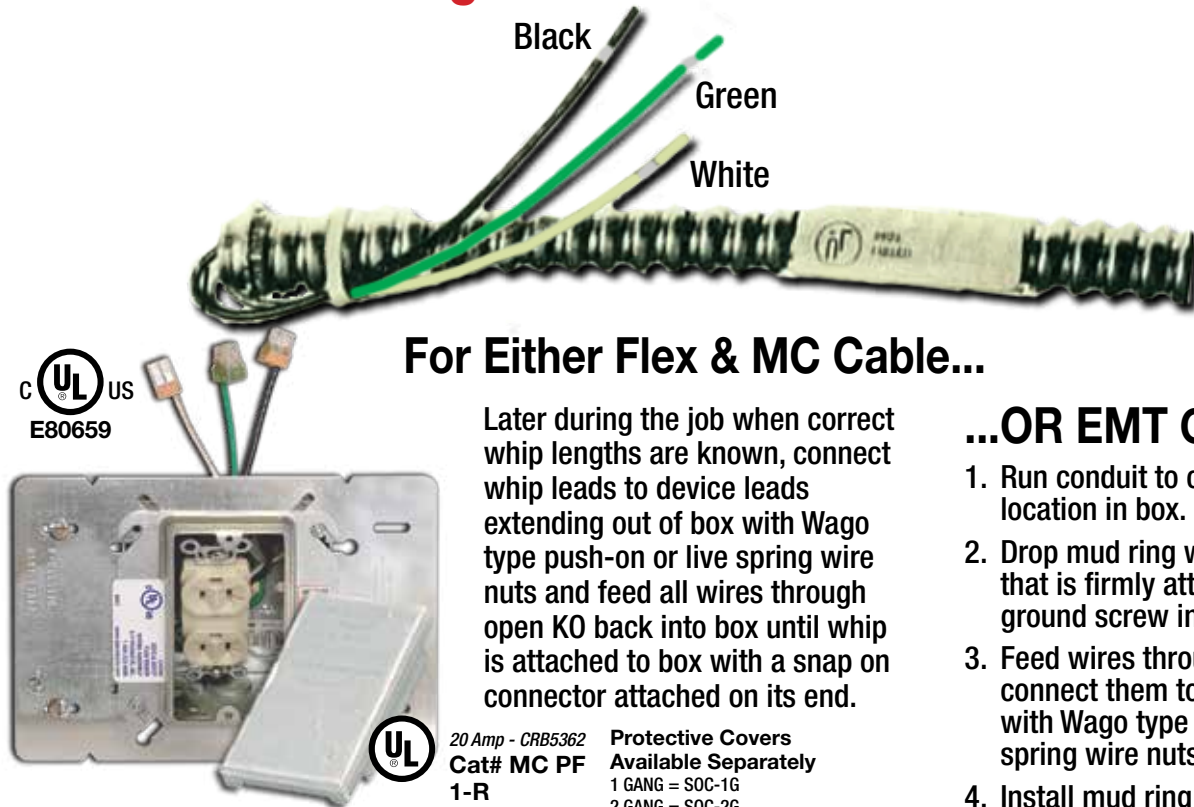

For Either Flex & MC Cable...

Later during the job when correct whip lengths are known, connect whip leads to device leads extending out of box with Wago type push-on or live spring wire nuts and feed all wires through open KO back into box until whip is attached to box with a snap on connector attached on its end.

...OR EMT Conduit

1. Run conduit to correct KO location in box.
2. Drop mud ring with device that is firmly attached to green ground screw in box.
3. Feed wires through conduit and connect them to device leads with Wago type push-on or live spring wire nuts.
4. Install mud ring with device back onto box.

Above assembly includes the following components

- 1- 4 square 1/2" - 3/4" KO x 2 1/8 deep box
- 1- 1 gang x 5/8" raised mud ring
- 1- 20 A specification grade CRB5362 back & side wired device tucked in or attached to mud ring
- 1- Single box support 16 gauge BSB1-FTD (IP28)

- 1- #12 stranded 8 inch pigtail grounded to box
- 3- #12 THNN stranded 8" long any color wire leads each with Wago push on quick connector or live spring wire nuts attached.
- 1- One or two gang protective cover (shown above) attached to mud ring.

Also Available without wiring devices and with any Type, Combination and Manufacturers Brand Components. If not Specified SP will Supply Equals.

Labor only orders also negotiated

Customer must satisfy all codes and owners' specifications.



PATENT PENDING
PATENTED



LABELS APPLY TO PRODUCTS ONLY WHERE SHOWN ABOVE

730 Pratt Boulevard • Elk Grove Village, IL 60007
P: (847) 593-8595 • F: (847) 593-8629 • Toll-free (800) 233-8595
E: info@spproducts.com • www.spproducts.com

PFA3

Adjustable Depth Mud Rings for 4 Square Outlet Boxes



Meets UL514
& CSA C22.2 No. 18.1

**Prevent Costly
Depth Problems
SAVE a Great Amount
of Time**

1 Gang

Cat# 1GADJMR-58-125

Cat# 1GADJMR-75-150

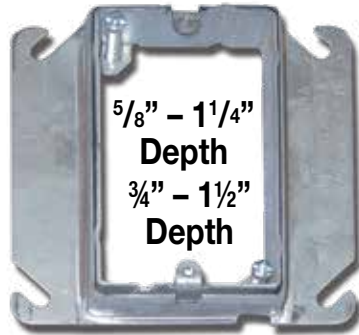

Cat# 2GADJMR - 2 Gang

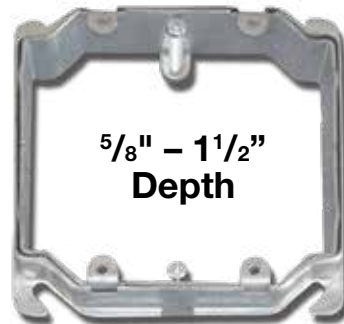

Adjusting screws NOT covered by drywall.

Eliminates lost time and damage to drywall when chipping out to expose adjusting screws.

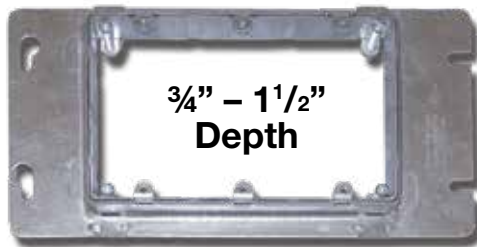

Cat# 3GADJMR - 3 Gang

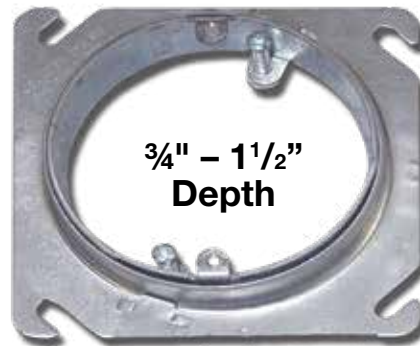

Cat# RADJMR - Round

**Provides complete flexibility to quickly
allow perfect alignment of devices**

Customer must satisfy all codes and owners' specifications.



PATENT PENDING
PATENTED

LABELS APPLY TO PRODUCTS ONLY WHERE SHOWN ABOVE



730 Pratt Boulevard • Elk Grove Village, IL 60007
P: (847) 593-8595 • F: (847) 593-8629 • Toll-free (800) 233-8595
E: info@spproducts.com • www.spproducts.com

PFA4

Grounding Pigtails

All Colors and Versions Available



Set Screw #12 THHN x 8"

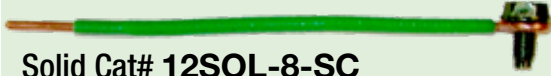

Solid Cat# 12SOL-8-SC
Stranded Cat# 12STR-8-SC

One End Stripped #12 THHN x 8"



Solid Cat# 12SOL-8-1ES
Stranded Cat# 12STR-8-1ES

Ring #12 THHN x 8"



Stranded Cat# 12STR-8-RT

Both Ends Stripped #12 THHN x 8"



Solid Cat# 12SOL-8-2ES
Stranded Cat# 12STR-8-2ES



Fork/Spade #12 THHN x 8"

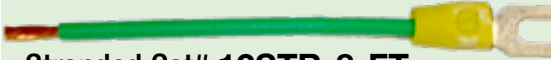

Stranded Cat# 12STR-8-FT

Ring End/Push On #12 THHN x 8"



Stranded Cat# 12STR-8-WA-RT

Custom Wire Leads



Green Ground Set Screw



Push On Type
UL Listed for 600 volt - 20 amp

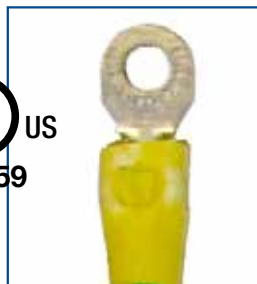

Ring Terminal



Spade or Fork Terminal

(insulated or uninsulated)



An unlimited variety of configurations with or without any type of above connectors, terminals, etc. attached at one or both ends, and in any type insulation, size, length, color, plain, or striped etc., solid or stranded wire are available. Consult Factory.

**Excellent quality with fast delivery
at extremely competitive prices**

Customer must satisfy all codes and owners' specifications.



PATENT PENDING
PATENTED



LABELS APPLY TO PRODUCTS ONLY WHERE SHOWN ABOVE

730 Pratt Boulevard • Elk Grove Village, IL 60007
P: (847) 593-8595 • F: (847) 593-8629 • Toll-free (800) 233-8595
E: info@spproducts.com • www.spproducts.com

PFA5

Vertical, Ceiling Adjustable Bar Hanger Assembly



Save over
40 MINUTES
per installation with a
PERFECT ALLIGNMENT
EVERY TIME!



**22 gauge galvanized
or stainless steel**

Perfect for Prefab!

**Provides a strong support &
flexibility for critical height
adjustments in T Bar Ceilings**

**Meets 50lb Load
Rating Requirement**



Customer must satisfy all codes and owners' specifications.



**PATENT PENDING
PATENTED**



LABELS APPLY TO PRODUCTS ONLY WHERE SHOWN ABOVE

730 Pratt Boulevard • Elk Grove Village, IL 60007
P: (847) 593-8595 • F: (847) 593-8629 • Toll-free (800) 233-8595
E: info@spproducts.com • www.spproducts.com

PFA6



Snap On/Off

Adjustable and Reusable Protective Covers

SAVE
a great amount
of time and money
on all outlets for
jobs throughout
the year!

Description	Catalog #
1-Gang	SOC-1G
2-Gang	SOC-2G
3-Gang	SOC-3G



- Steel flanges are inserted into inside of mud ring to allow routers to cut a smaller opening.
- Covers suitable for all manufacturers' brands including adjustable mud rings.
- Device cover is used for protection of wiring devices prior to energizing circuit.



1-Gang = SOC-1G
PATENTED

2-Gang = SOC-2G
PATENTED



3-Gang = SOC-3G
PATENTED

Also suitable when wire devices are connected to leads and tucked into back of deep boxes

Customer must satisfy all codes and owners' specifications.



PATENT PENDING
PATENTED

LABELS APPLY TO PRODUCTS ONLY WHERE SHOWN ABOVE



730 Pratt Boulevard • Elk Grove Village, IL 60007
P: (847) 593-8595 • F: (847) 593-8629 • Toll-free (800) 233-8595
E: info@spproducts.com • www.spproducts.com

TE1



Rigid Pipe Joiner

Spins 10 Foot Lengths Together in Under 10 Seconds with Less Chance of Injury

Catalog #	Size
PS125	1¼"
PS150	1½"
PS200	2"
PS250	2½"
PS300	3"
PS350	3½"
PS400	4"
PS500	5"
PS600	6"

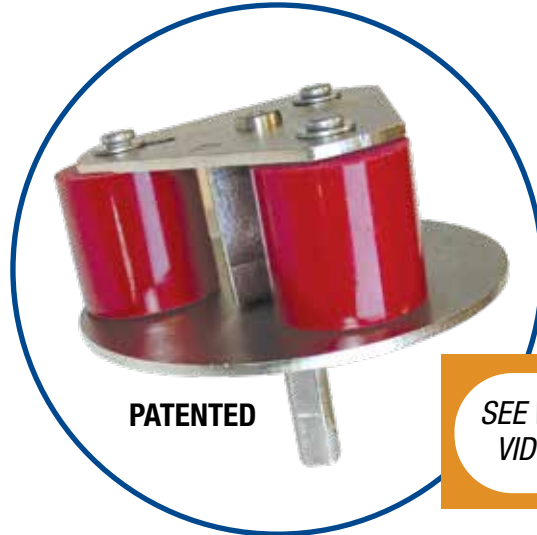

PATENTED

SEE WEBSITE
VIDEO **TE2**

• When shaft turns, grips expand to lock on inside of conduit and spin it 360° to join the entire 10 foot length into the preceding coupling. Drill can be reversed to disconnect conduit.

• Eliminates labor intensive ropes or chain and heavy hard to handle strap wrenches.

• Spinners available in sets at reduced prices or sold separately.

WHEN USING CUTTING OIL, REMOVE WITH A PROPER SOLUTION. DO NOT INSERT ANY FOREIGN MATERIALS IN AN ATTEMPT TO PREVENT SLIPPAGE.

NO POWER SOURCE NEEDED

SUITABLE FOR USE IWHT
MILWAUKEE 0721-21 V28
VOLT RIGHT ANGLE
CORDLESS DRILL

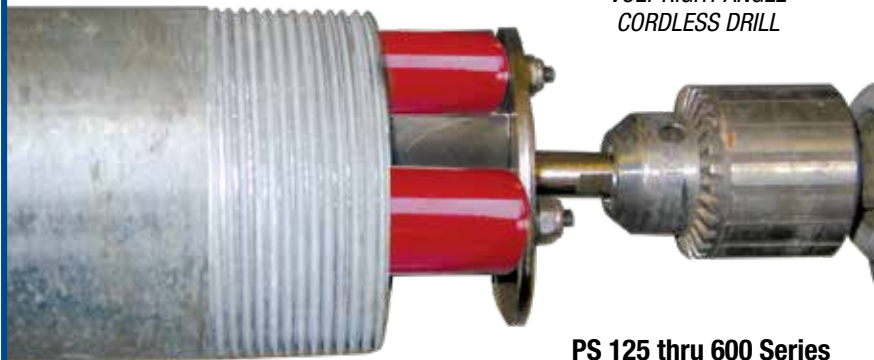

PS 125 thru 600 Series

Prevents Damage to Inside and Outside of Conduit – Especially PVC Coated

Customer must satisfy all codes and owners' specifications.



PATENT PENDING
PATENTED

LABELS APPLY TO PRODUCTS ONLY WHERE SHOWN ABOVE



730 Pratt Boulevard • Elk Grove Village, IL 60007
P: (847) 593-8595 • F: (847) 593-8629 • Toll-free (800) 233-8595
E: info@spproducts.com • www.spproducts.com

TE2



Lamp Guard

With Built in Socket and Leads for Temporary Lighting in Stairwells or Poured in Place Concrete Locations, etc.

Cat# LG100

PATENTED

NEW!

Leads are totally enclosed in box

MOUNT TO BOXES



**High Quality
250 Volts
660 Watts Rated
UL Listed Socket**

**For Incandescent Bulbs,
Fluorescent Bulbs & Led Lights**

**Fits on 3/0 Mud Ring
Single Gang Mud Ring
3/0 & 4/0 Octagon Boxes**



- Safer, extremely FASTER installation.
- Eliminates all expensive exposed wire which often has to be scrapped later.
- Attach each lamp directly to power in box to use only where light is needed.
- Built-in slots allow fast installation and removing guard from outlet box.
- Design no wider than a plaster ring allows wall finishers to apply materials without having to remove the fixture.
- One time installation. Not removed until job is completed.
- Strong and Durable High Quality.
- Non-Flammable Delron Material.
- Dimensions 5-3/4" H x 3-1/8"W

High Quality Non-Flammable Delron Material

Customer must satisfy all codes and owners' specifications.



PATENT PENDING
PATENTED



LABELS APPLY TO PRODUCTS ONLY WHERE SHOWN ABOVE

730 Pratt Boulevard • Elk Grove Village, IL 60007

P: (847) 593-8595 • F: (847) 593-8629 • Toll-free (800) 233-8595

E: info@spproducts.com • www.spproducts.com

TE3

Poly Foam Box Insert

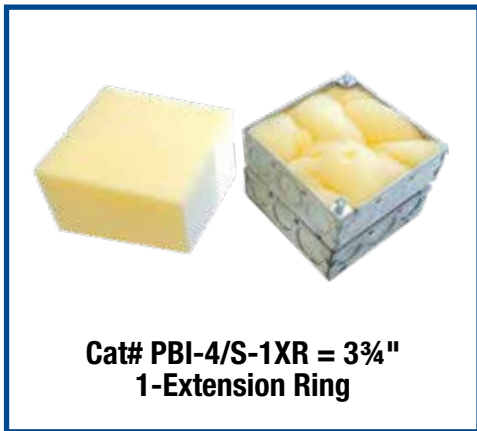
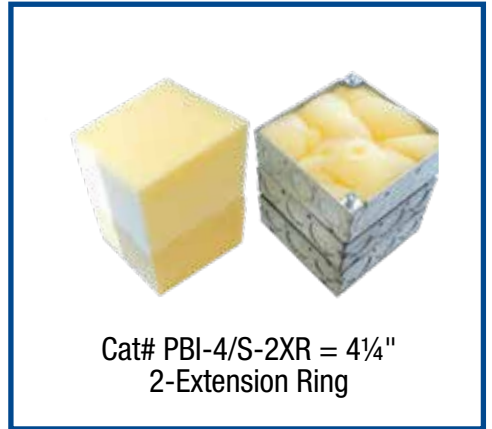
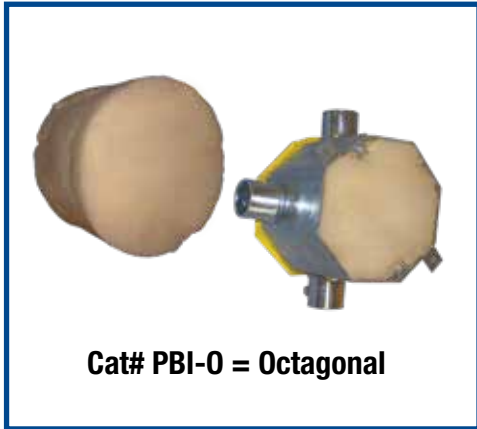

- Prevents Concrete from Entering Boxes
- Fast and Easy to Install
- Reusable for 8 or more applications



PATENTED

- Saves Over 5 Minutes, Plus Cost of Tape
- For All Types of Boxes on Poured in Place Concrete Jobs

Traditional Method of Taping Box to Keep Out Concrete During Pour

**Available in a Wide Variety of Other Configurations
Consult Factory for more Information**

Customer must satisfy all codes and owners' specifications.



PATENT PENDING
PATENTED



LABELS APPLY TO PRODUCTS ONLY WHERE SHOWN ABOVE

730 Pratt Boulevard • Elk Grove Village, IL 60007
P: (847) 593-8595 • F: (847) 593-8629 • Toll-free (800) 233-8595
E: info@spproducts.com • www.spproducts.com

TE4



Cut'N'Catch



PATENT PENDING

Only 1 worker needed to cut any type conduit, strut, threaded rod up thru 6" size

Cut'N'Catch kit contains 7 pieces (circled in blue) designed to work with stand and rebar (not included) as pictured.



- Portable, use anytime, anywhere on job sites & prefab shops
- Accommodates any length of conduit, strut, threaded rod, etc.
- Securely clamps any length material safely in place for cutting
- Ideal for all trades; Electricians, Plumbers, HVAC, Carpenters, etc.
- "Claws" secure bandsaw and protect from expensive damage by falling
- Allows for a cleaner cut and eliminates burrs - NO FILING required
- Catches cutoff in V-Glides to keep pieces off the ground

Eliminates the dangerous "Captain Morgan" method! BOTH hands remain free to operate bandsaw.

Customer must satisfy all codes and owners' specifications.



PATENT PENDING
PATENTED



LABELS APPLY TO PRODUCTS ONLY WHERE SHOWN ABOVE

730 Pratt Boulevard • Elk Grove Village, IL 60007
P: (847) 593-8595 • F: (847) 593-8629 • Toll-free (800) 233-8595
E: info@spproducts.com • www.spproducts.com

TE5

SCH 40 & 80



PVC Reaming Bits for Transition Couplings

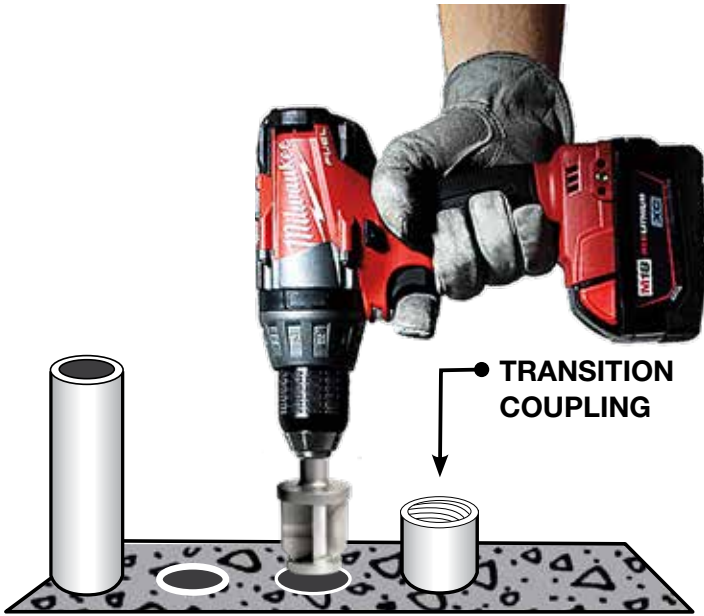

TRANSITION
COUPLING



1-Piece
Larger sizes available
on special order

PATENT
PENDING

High Quality Steel
Sharpenable for
Long Life

PVC Conduit Size	SCH 40 PVC Catalog #	PVC Conduit Size	SCH 40 PVC Catalog #
1/2"	IPRB50-SCH 40	2 1/2"	IPRB250-SCH 40
3/4"	IPRB75-SCH 40	3"	IPRB300-SCH 40
1"	IPRB100-SCH 40	3 1/2"	IPRB350-SCH 40
1 1/4"	IPRB125-SCH 40	4"	IPRB400-SCH 40
1 1/2"	IPRB150-SCH 40	5"	IPRB500-SCH 40
2"	IPRB200-SCH 40	6"	IPRB600-SCH 40

1/2" & 4" = 1/2" Chuck

PVC Conduit Size	SCH 80 PVC Catalog #	PVC Conduit Size	SCH 80 PVC Catalog #
1/2"	IPRB50-SCH 80	2 1/2"	IPRB250-SCH 80
3/4"	IPRB75-SCH 80	3"	IPRB300-SCH 80
1"	IPRB100-SCH 80	3 1/2"	IPRB350-SCH 80
1 1/4"	IPRB125-SCH 80	4"	IPRB400-SCH 80
1 1/2"	IPRB150-SCH 80	5"	IPRB500-SCH 80
2"	IPRB200-SCH 80	6"	IPRB600-SCH 80

5" & 6" = 3/4" Chuck

NO PARTS TO LOSE ON THE JOB SITE!

Customer must satisfy all codes and owners' specifications.



PATENT PENDING
PATENTED



LABELS APPLY TO PRODUCTS ONLY WHERE SHOWN ABOVE

730 Pratt Boulevard • Elk Grove Village, IL 60007
P: (847) 593-8595 • F: (847) 593-8629 • Toll-free (800) 233-8595
E: info@spproducts.com • www.spproducts.com

TE6

Chamfer Bits

for SCH 40/80 PVC Conduits



NEW

Conduit reaming tool smooths wall of conduit with a 30° chamfer around all 360° of conduit to eliminate sharp edges to prevent wire damage and to receive mandrel for wire pull.

Meets utility requirements.
Tool works for both Schedule 40 & 80 .

1-Piece
Larger sizes available
on special order
1/2" thru 6"

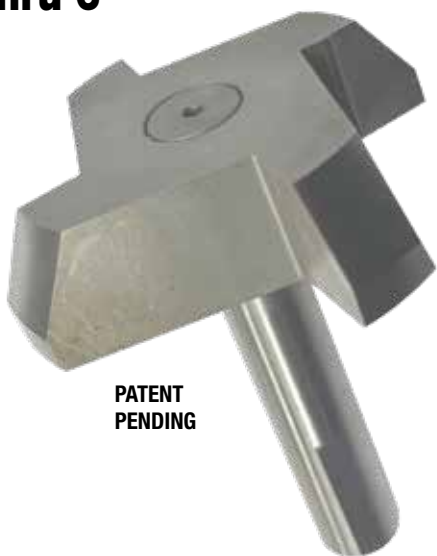

PATENT PENDING

1/2" thru 4"
1/2" Chuck

5" thru 8"
3/4" Chuck

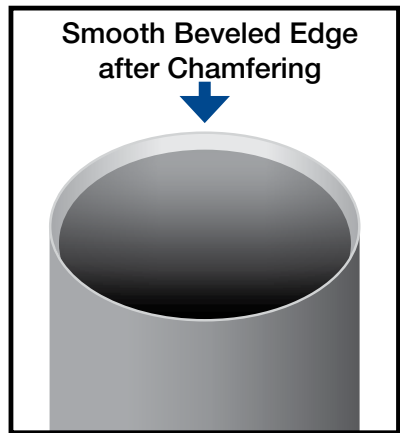

Smooth Beveled Edge
after Chamfering

< Conduit Before

PVC Conduit Size	SCH 40/80 Catalog #	PVC Conduit Size	SCH 40/80 Catalog #
1/2"	CHRB50-SCH 40/80	3"	CHRB300-SCH 40/80
3/4"	CHRB75-SCH 40/80	3 1/2"	CHRB350-SCH 40/80
1"	CHRB100-SCH 40/80	4"	CHRB400-SCH 40/80
1 1/4"	CHRB125-SCH 40/80	5"	CHRB500-SCH 40/80
1 1/2"	CHRB150-SCH 40/80	6"	CHRB600-SCH 40/80
2"	CHRB200-SCH 40/80	8"	CHRB800-SCH 40/80
2 1/2"	CHRB250-SCH 40/80		



PATENT PENDING
PATENTED



LABELS APPLY TO PRODUCTS ONLY WHERE SHOWN ABOVE

730 Pratt Boulevard • Elk Grove Village, IL 60007
P: (847) 593-8595 • F: (847) 593-8629 • Toll-free (800) 233-8595
E: info@spproducts.com • www.spproducts.com

TE6a

Chamfer Bits



for Aluminum & Galvanized Rigid Conduit



- Deburrs at any location
- Provides smooth chamfer
- Safer, Better & Faster
- Works with any type of drill with 1/2" chuck



4 Lobes
Conduit Sizes
1/2" thru
2-1/2"



5 Lobes
Conduit Sizes
3" & 4"

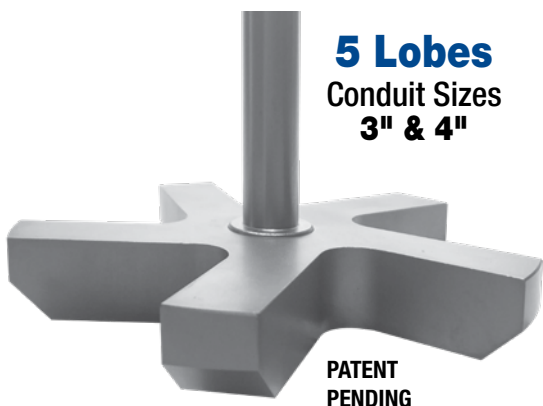

PATENT
PENDING

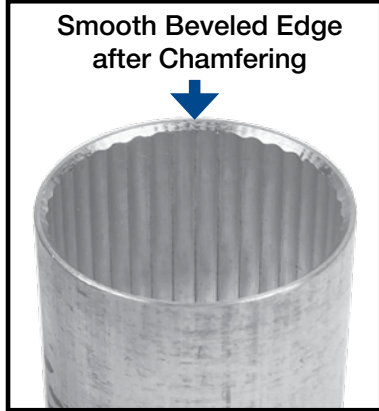

Catalog #	Conduit Size
ALCE-50-75-100	1/2"-3/4"-1"
ALCE-125-150	1-1/4"-1-1/2"
ALCE-200-250	2"-2-1/2"
ALCE-300-350	3"-3-1/2"
ALCE-400	4"

1/2" thru 4"
1/2" Chuck



PATENT PENDING
PATENTED



LABELS APPLY TO PRODUCTS ONLY WHERE SHOWN ABOVE

730 Pratt Boulevard • Elk Grove Village, IL 60007
P: (847) 593-8595 • F: (847) 593-8629 • Toll-free (800) 233-8595
E: info@spproducts.com • www.spproducts.com

TE6b



Live Panel Lockout Brackets

Extremely Safe – Save Time Everyday

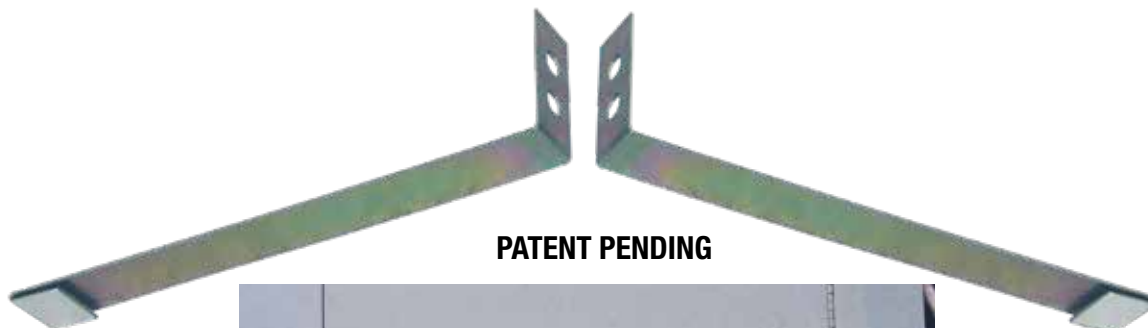

PATENT PENDING



**Locks & keys
for brackets
sold separately.
Consult Factory
for additional
cost.**

- **On/Off in seconds**
- *Lock it to Eliminate entry by unauthorized personnel*
- *Brackets sold in pairs*
- *Locks and keys sold separately*
- *Two holes provided on each piece for two locks*
- *Strong 18 gauge zinc plated steel, reusable with long life*

Common Sizes

- LOB 20" wide panel
- LOB 36" wide panel
- LOB 40" wide panel

**An unlimited variety
of other panel widths
available.**

**FOR USE AS AN ACCESS DETERRENT –
NOT FOR PROTECTION AGAINST ELECTRICAL SHOCK!**

Customer must satisfy all codes and owners' specifications.



PATENT PENDING
PATENTED



LABELS APPLY TO PRODUCTS ONLY WHERE SHOWN ABOVE

730 Pratt Boulevard • Elk Grove Village, IL 60007
P: (847) 593-8595 • F: (847) 593-8629 • Toll-free (800) 233-8595
E: info@spproducts.com • www.spproducts.com

TE7



Live Panel Temporary Covers



Provide Protection for Construction Workers, Visitors, and Tenants



Extremely Safe 600 Volt Rated



20" X 48" Cat# TPC 20 X 48
14" X 48" Cat# TPC 14 X 48

Other sizes available on special order

ON/OFF in Seconds Highly Visible – Improves Image on Jobsite

Non-Conductive Magnets Securely Fastens Cover to Panel

Panels available with pre-drilled holes for nuts, bolts and washers to securely attach panel. Customer must specify size and exact locations required. Covers also available with nuts, bolt and washers installed.

ANSI Z535.1, ANSI Z535.2, ANSI Z535.3, ANSI Z535.4, ANSI Z535.5, ANSI Z535.6

For Use as an Access Deterrent – Not For Protection Against Electrical Shock!

Customer must satisfy all codes and owners' specifications.



PATENT PENDING
PATENTED



LABELS APPLY TO PRODUCTS ONLY WHERE SHOWN ABOVE

730 Pratt Boulevard • Elk Grove Village, IL 60007
P: (847) 593-8595 • F: (847) 593-8629 • Toll-free (800) 233-8595
E: info@spproducts.com • www.spproducts.com

TE8



Portable Cable Pullers for Power, Data, etc. in Light Poles

Small Puller (pair shown)

Cat# PWP 100-S
2.7 lbs Each

NEW!

**USE
IN SETS
OF TWO**

Extra-Small Puller (not shown)

Cat# PWP 100-ES
2.3 lbs Each

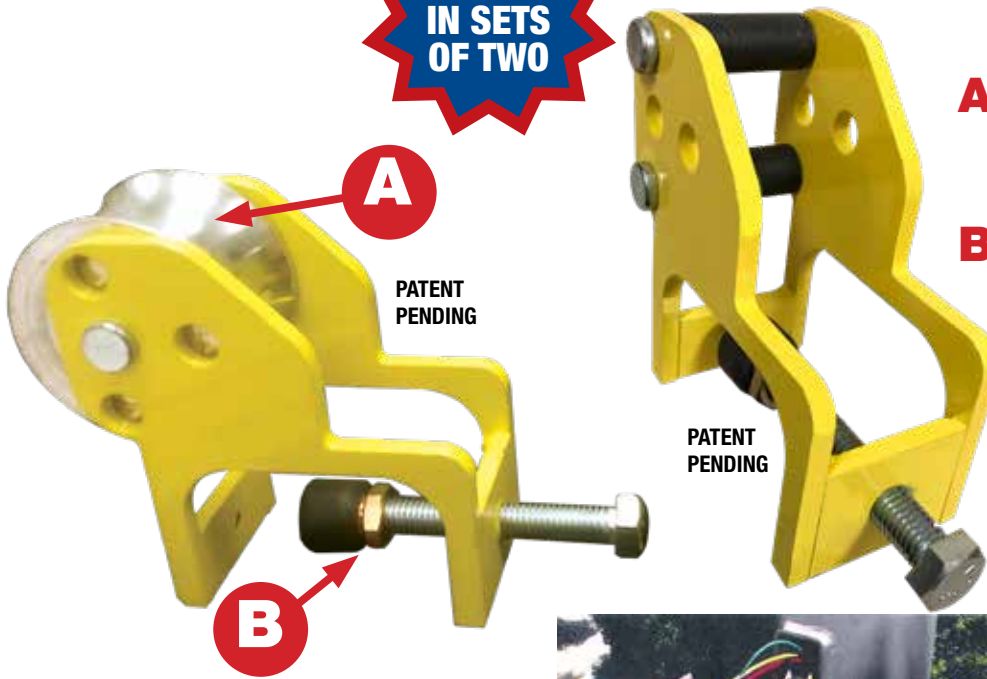

A Extremely durable grooved bearing grade wheel receives and controls cables during the pull

B Heavy duty bolt secures cable puller to pole hand hole and strong plastic cap protects pole from damage when attached

- Quickly Attach to Hand Hole of Each and Pull Wire All While Standing Ground to Reduce Chance of Injury
- Use in Sets of Two
- Eliminate Damage to Poles and Wire
- Extremely Safer and Faster



2 Electricians Walked from Pole to Pole and Pulled Over 52,000 Feet of #4 Cable in One Day or Only 16 Total Hours!

Customer must satisfy all codes and owners' specifications.



PATENT PENDING
PATENTED



LABELS APPLY TO PRODUCTS ONLY WHERE SHOWN ABOVE

730 Pratt Boulevard • Elk Grove Village, IL 60007
P: (847) 593-8595 • F: (847) 593-8629 • Toll-free (800) 233-8595
E: info@spproducts.com • www.spproducts.com

TE9

Anchor Bolt Templates



Extremely Fast, Accurate Installation For Light Poles, Beams, etc.

**Each Template
Saves 100's of
Dollars!**

**Extremely Fast,
Accurate Installation
For Light Poles,
Beams, etc.**

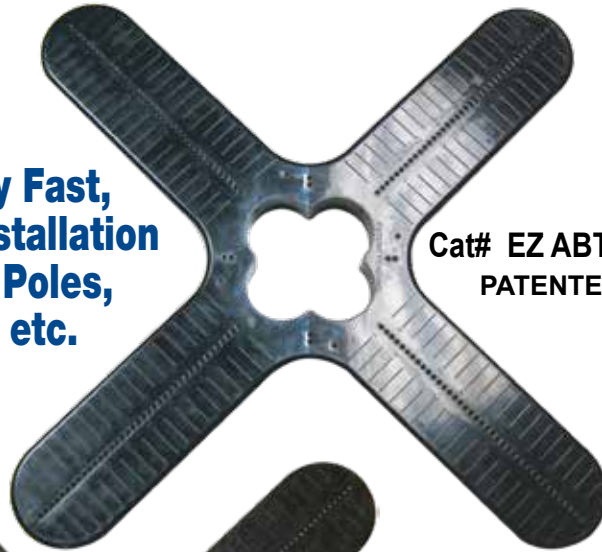

Cat# EZ ABT-800
PATENTED

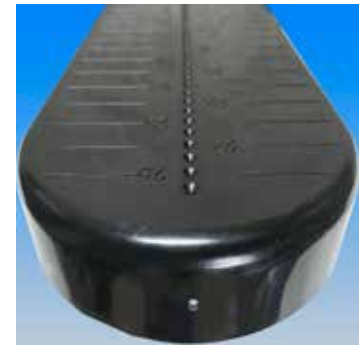

Cat# EZ ABT-2.3
PATENTED

**Improved Version
for Light Rail Jobs
Requiring Two
3" Conduits**

*A 1/4" hole can be provided
on end of each wing upon request
for fast and secure installation
of the template to sonotube
before the concrete pour*

- Rulers on all 4 wings allow drilling same bolt diameter holes for 5½ thru 25 inch four bolt circle patterns.
- Color code templates for each bolt diameter and drill different circle patterns from job to job.
- Embedded divots ensure accuracy when drilling.
- Deep recess in back allows leveling nut to be free of concrete.
- Strong extremely long-lasting non-corrosive ABS plastic.

Eliminate constantly purchasing and fabricating expensive plywood.

Customer must satisfy all codes and owners' specifications.



Productivity and value thru ideas



PATENT PENDING
PATENTED

LABELS APPLY TO PRODUCTS ONLY WHERE SHOWN ABOVE



730 Pratt Boulevard • Elk Grove Village, IL 60007
P: (847) 593-8595 • F: (847) 593-8629 • Toll-free (800) 233-8595
E: info@spproducts.com • www.spproducts.com

TE10-11

PVC Conduit Bender



Portable – No Power Needed!

Use Anytime – Anywhere – On Job Site Eliminates expensive Hot Boxes, Heat Blankets, Generators, etc. Up Thru 6 Inch Schedule 40 & 80



MH18835

Cat# HB400

**Complete With:
Bender, Wire Heat Guard,
25 ft. Hose, Brass Regulator
All in strong steel carrying**

**NOTE: Customer supplies
5 gallon propane tank**

ONE FREE Bender Supplied for every \$100,000 of Qwik Duct Templates, End Bells and/or Transition Couplings ordered. Orders can be assorted and accumulated for a maximum period of 12 months from date of first order. If Bender's are not available and customer achieves above goal he will receive a 2% credit on Template, End Bell and/or Transition Couplings purchases during the period. Customer must accept this offer with a dated signed agreement.

Customer must satisfy all codes and owners' specifications.



**PATENT PENDING
PATENTED**

LABELS APPLY TO PRODUCTS ONLY WHERE SHOWN ABOVE



730 Pratt Boulevard • Elk Grove Village, IL 60007
P: (847) 593-8595 • F: (847) 593-8629 • Toll-free (800) 233-8595
E: info@spproducts.com • www.spproducts.com

TE12

Dry Wall Cut Out Templates



Allow Fast, Perfectly Spaced and Level Cut Outs with NO DAMAGE to Drywall

Cat# COT100
PATENTED

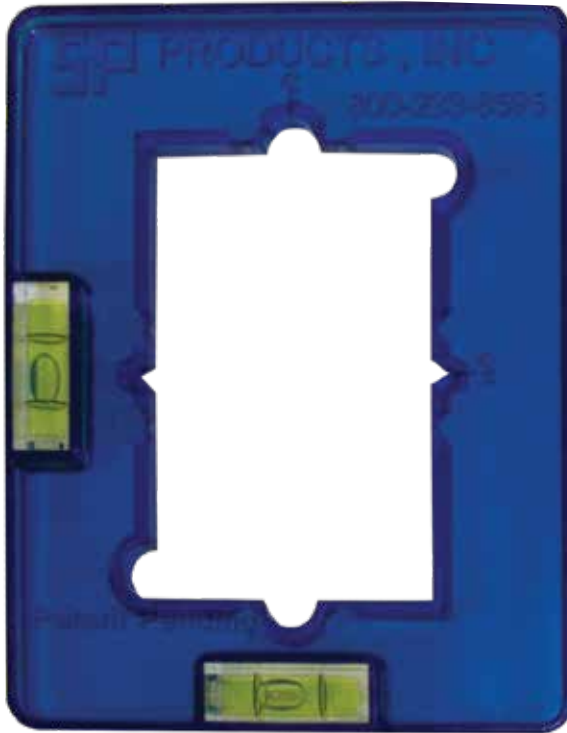

- Two levels provided for perfect horizontal and vertical alignment
- Center lines provided for accuracy – especially when ganging cut outs
- Clear see thru blue polycarbonate material

Allows tracing all box
and screw openings.

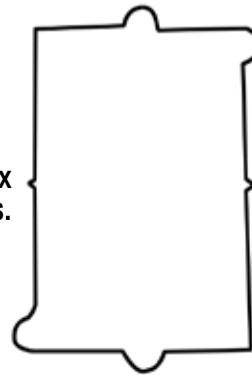

Extremely Strong and Durable, Save Hundreds of Dollars Every Year

Customer must satisfy all codes and owners' specifications.



PATENT PENDING
PATENTED



LABELS APPLY TO PRODUCTS ONLY WHERE SHOWN ABOVE

730 Pratt Boulevard • Elk Grove Village, IL 60007
P: (847) 593-8595 • F: (847) 593-8629 • Toll-free (800) 233-8595
E: info@spproducts.com • www.spproducts.com

TE13



PVC Driver

for Joining SCH 40/80 PVC Conduit



1-Piece

Assemble PVC conduits in a Duct Bank on a job site or prefab using the PVC Driver with a Hammer Drill to join 2 pieces of PVC conduit in a matter of seconds.

PVC Driver eliminates extra tools and allows for a clean and safe installation with less labor.

Insert PVC Driver into Hammer Drill and drive PVC Conduit into place with this light weight aluminum tool for **SAFER, BETTER, FASTER** jobs.



PATENT PENDING

Catalog #	SCH 40/80 PVC Conduit Size
PVCD-100-125-150	1", 1-1/4" & 1-1/2"
PVCD-200-250-300	2", 2-1/2" & 3"
PVCD-350-400	3-1/2" & 4"
PVCD-500	5"
PVCD-600	6"
PVCD-800	8"



PATENT PENDING
PATENTED



LABELS APPLY TO PRODUCTS ONLY WHERE SHOWN ABOVE

730 Pratt Boulevard • Elk Grove Village, IL 60007
P: (847) 593-8595 • F: (847) 593-8629 • Toll-free (800) 233-8595
E: info@spproducts.com • www.spproducts.com

IP14



Terms & Conditions

**ALL PRICES ARE SUBJECT TO
CHANGE WITHOUT NOTICE**

1. Cash Discount 2% 10 Days, Net 30. F.O.B. Factory, Elk Grove Village, IL 60007
2. Freight allowed on \$3,500 or more of all products other than Duct Bank Templates, EZ Pull Wiring Harnesses, Econo Whips, and all types of Prefabricated Assemblies
3. Freight on Duct Bank Templates, EZ Pull Wiring Harnesses, all of Econo Whips, Prefabricated Assemblies is negotiated on an individual order basis. If freight requirements are met on orders for these products, any quantity of all other products shown on price sheet, may be Included to become freight allowed.
4. Terms apply on one shipment to one location within the continental USA. For Alaska, Hawaii, Puerto Rico and else where, consult factory.
5. 50% restocking charge plus freight charges both ways, on all products other than specials noted in paragraph 3 & 4 above provided material is in saleable condition based on our inspection. No returns accepted if purchase order is older than 1 year.
6. All types of wiring harnesses including harnesses in all types of flexible conduit, twisted or striped wire, Qwik Duct Custom Templates, pre-fabricated boxes with wiring devices installed and all other prefabricated products are absolutely not returnable.
7. Customer can order any piece quantity.

Customer must satisfy all codes and owners' specifications.



PATENT PENDING
PATENTED



LABELS APPLY TO PRODUCTS ONLY WHERE SHOWN ABOVE

730 Pratt Boulevard • Elk Grove Village, IL 60007
P: (847) 593-8595 • F: (847) 593-8629 • Toll-free (800) 233-8595
E: info@spproducts.com • www.spproducts.com